



# **Hydrolab DS5X, DS5, and MS5 Water Quality Multiprobes**

USER MANUAL

February 2006, Edition 3



# Table of Contents

---

<b>Section 1 Specifications</b> .....	5
<b>Section 2 General Information</b> .....	9
2.1 Safety Information.....	9
2.1.1 Use of Hazard Information.....	9
2.1.2 Precautionary Labels.....	9
2.2 DS5, DS5X Multiprobe.....	10
2.3 MS5 Multiprobe.....	10
2.4 Sensor Options.....	11
2.4.1 DS5 Sensor Options.....	12
<b>Section 3 Installation</b> .....	15
3.1 Unpacking the Instrument.....	15
3.2 Instrument Assembly.....	15
3.3 Power Options.....	16
<b>Section 4 Operation</b> .....	19
4.1 Parameter Setup.....	19
4.1.1 Using the Surveyor for Parameter Setup.....	19
4.1.2 Using Hydras 3 LT for Parameter Setup.....	20
4.1.3 Specific Conductance Parameter Setup.....	20
4.1.4 Clark Cell Dissolved Oxygen Parameter Setup.....	22
4.1.5 pH Parameter Setup.....	22
4.1.6 Other Parameter Setup.....	22
4.2 Calibration.....	22
4.2.1 Calibrating the Sensors Using the Surveyor.....	22
4.2.2 Calibrating the Sensors Using Hydras 3 LT.....	23
4.2.3 Calibration Preparation.....	24
4.2.4 Temperature Sensor Calibration.....	25
4.2.5 Specific Conductance Calibration.....	25
4.2.6 Clark Cell Dissolved Oxygen Sensor Calibration.....	25
4.2.6.1 Water-Saturated Air Dissolved Oxygen Calibration.....	25
4.2.6.2 Known Concentration Dissolved Oxygen Calibration.....	26
4.2.7 Pressure Sensor Calibration.....	27
4.2.8 pH/ORP Calibration.....	27
4.2.9 Other Sensor Calibrations.....	27
4.3 Using the DS5/MS5 for Short Term Deployments.....	27
4.3.1 Gathering Data Using the Surveyor.....	27
4.3.2 Gathering Data Using a PC and Hydras 3 LT.....	27
4.3.3 Using the DS5/DS5X/MS5 for Unattended Monitoring.....	27
4.3.3.1 Creating Log Files.....	27
4.3.3.2 Downloading Log Files.....	28
<b>Section 5 Deployment</b> .....	29
5.1 Deployment Considerations.....	29
5.1.1 Pressure Extremes.....	29
5.1.2 Temperature Extremes.....	29
5.1.3 Data Transmission Lines.....	29
5.1.4 Minimum Depth Requirements.....	29
5.2 Deployment in Open Waters.....	30
5.2.1 Minimum Clearance Requirements.....	30
5.2.2 Long-term Deployment in Open Waters.....	30
5.2.2.1 Anchoring the DS5 or DS5X using the Support Bail.....	31
5.2.2.2 Anchoring the MS5 using the Bail Kit.....	32
5.2.2.3 Anchoring the MS5 using the Mooring Fixture.....	32

# Table of Contents

---

5.2.3 Short-term Deployment in Open Waters .....	33
5.2.4 Minimum Flow Requirements.....	35
5.2.5 Non-submersible Deployment.....	35
<b>Section 6 Maintenance</b> .....	<b>37</b>
6.1 Multiprobe and Accessory Maintenance.....	37
6.1.1 Cleaning the Multiprobe Housing.....	37
6.1.2 Dryer Maintenance.....	37
6.1.3 FreshFlow™ Miniature Sample Circulator Maintenance.....	38
6.2 Battery Replacement .....	38
6.2.1 DS5 and DS5X Battery Replacement .....	38
6.2.2 MS5 Battery Replacement .....	39
6.2.3 Lithium Battery Replacement .....	40
6.3 Storage and Care Recommendations .....	42
6.3.1 Multiprobe and Sensor Storage .....	42
6.3.2 Electrical Cable Care .....	42
6.4 Sensor Maintenance.....	43
6.5 Clark Cell Dissolved Oxygen Maintenance .....	43
6.6 Specific Conductance, Salinity, and TDS Maintenance .....	44
6.7 ORP Sensor Maintenance.....	44
6.8 pH Electrode Maintenance .....	44
6.8.1 Standard Reference Electrode .....	45
6.8.2 pH Integrated Sensor .....	46
6.9 Temperature Sensor Maintenance .....	46
6.10 Pressure Sensor Maintenance .....	46
6.11 Other Sensor Maintenance .....	46
<b>Section 7 Replacement Parts and Accessories</b> .....	<b>47</b>
<b>Section 8 How to Order</b> .....	<b>49</b>
<b>Section 9 Repair Service</b> .....	<b>50</b>
<b>Section 10 Limited Warranty</b> .....	<b>51</b>
<b>Appendix A Troubleshooting</b> .....	<b>53</b>
<b>Appendix B External Communications</b> .....	<b>57</b>
B.1 SDI-12 Interface .....	57
B.2 Connection to an External Device .....	58
B.3 RS485 Interface.....	60
B.4 Modbus Interface.....	60
B.5 Using a Modem with Multiprobes .....	62
B.6 TTY Mode.....	64
B.6.1 TTY Menu and Commands .....	65
B.6.2 Data Display .....	66
<b>Appendix C Using HyperTerminal</b> .....	<b>67</b>
C.1 HyperTerminal Setup .....	67
<b>Appendix D Glossary &amp; Abbreviations</b> .....	<b>69</b>

# Section 1 Specifications

Specifications are subject to change without notice.

DS5 and DS5X Transmitter	
Outer Diameter	8.9 cm (3.5 in.)
Length	58.4 cm (23 in.)
Weight (typical configuration)	3.35 kg (7.4 lb)
Maximum Depth	225 m
Operating Temperature	-5 to 50 °C
Battery Supply (optional)	8 C batteries
Computer Interface	RS232, SDI-12, RS485
Memory (optional)	120,000 measurements
MS5 Transmitter	
Outer Diameter	4.4 cm (1.75 in.)
Length	53.3 cm (21 in.) 74.9 cm (29.5 in.) with battery pack
Weight (typical configuration)	1.0 kg (2.2 lb) 1.3 kg (2.9 lb) with battery pack
Maximum Depth	225 m
Operating Temperature	-5 to 50 °C
Battery Supply (optional)	8 AA batteries
Computer Interface	RS232, SDI-12, RS485
Memory (optional)	120,000 measurements
Temperature Sensor	
Range	-5 to 50 °C
Accuracy	± 0.10 °C
Resolution	0.01 °C
Specific Conductance Sensor	
Range	0 to 100 mS/cm
Accuracy	± 1% of reading; ± 0.001 mS/cm
Resolution	0.0001 units
pH Sensor	
Range	0 to 14 units
Accuracy	± 0.2 units
Resolution	0.01 units

## Specifications

Clark Cell Dissolved Oxygen Sensor	
Range	0 to 50 mg/L
Accuracy	± 0.2 mg/L at ≤ 20 mg/L ± 0.6 mg/L at > 20 mg/L
Resolution	0.01 mg/L
ORP	
Range	−999 to 999 mV
Accuracy	± 20 mV
Resolution	1 mV
Depth Vented Level	
Range	0 to 10 m
Accuracy	± 0.01 m
Resolution	0.001 m
Depth 0–25 m	
Range	0 to 25 m
Accuracy	± 0.05 m
Resolution	0.01 m
Depth 0–100 m	
Range	0 to 100 m
Accuracy	± 0.05 m
Resolution	0.01 m
Depth 0–200 m	
Range	0 to 200 m
Accuracy	± 0.1 m
Resolution	0.1 m
Hach LDO® Sensor	
Range	0–30 mg/L
Accuracy	± 0.01 mg/L for 0–8 mg/L; ± 0.02 mg/L for greater than 8 mg/L
Resolution	0.01 or 0.1 mg/L
Salinity	
Range	0 to 70 ppt
Accuracy	± 0.2 ppt
Resolution	1 mV
4-beam Turbidity (DS5 Only)	
Range	0 to 1000 NTU
Accuracy	± 5% of reading; ± 1 NTU
Resolution	0.1 NTU (<100 NTU); 1NTU (≥ 100 NTU)

<b>Self-cleaning Turbidity</b>	
<b>Range</b>	0 to 3000 NTU
<b>Accuracy</b>	± 1% up to 100 NTU, ± 3% up to 100–400 NTU, ± 5% from 400–3000 NTU
<b>Resolution</b>	0.1, up to 400 NTU; 1.0, 400–3000 NTU
<b>Ammonium/Ammonia</b>	
<b>Range</b>	0 to 100 mg/L-N
<b>Accuracy</b>	Greater of ± 5% of reading or ± 2 mg/L-N (typical)
<b>Resolution</b>	0.01 mg/L-N
<b>Nitrate</b>	
<b>Range</b>	0 to 100 mg/L-N
<b>Accuracy</b>	Greater of ±5% of reading or ±2 mg/L-N (typical)
<b>Resolution</b>	0.01 mg/L-N
<b>Chloride</b>	
<b>Range</b>	0.5 to 18,000 mg/L
<b>Accuracy</b>	Greater of ± 5% of reading or ± 2 mg/L (typical)
<b>Resolution</b>	0.0001 units
<b>Total Dissolved Gas</b>	
<b>Range</b>	400 to 1300 mmHg
<b>Accuracy</b>	± 0.1% of span
<b>Resolution</b>	1.0 mmHg
<b>Ambient Light</b>	
<b>Range</b>	0 to 10,000 $\mu\text{mol s}^{-1} \text{m}^{-2}$
<b>Accuracy</b>	± 5% of reading or ± 1 $\mu\text{mol s}^{-1} \text{m}^{-2}$
<b>Resolution</b>	1 $\mu\text{mol s}^{-1} \text{m}^{-2}$
<b>Chlorophyll a</b>	
<b>Range</b>	0 to 500 $\mu\text{g/L}$ , 0 to 50 $\mu\text{g/L}$ , 0 to 5 $\mu\text{g/L}$
<b>Accuracy</b>	± 3% for signal level equivalents of 1 ppb Rhodamine WT dye
<b>Resolution</b>	0.01 $\mu\text{g/L}$
<b>Rhodamine WT</b>	
<b>Range</b>	0 to 1000 ppb, 0 to 100 ppb, 0 to 10 ppb
<b>Accuracy</b>	± 3% for signal level equivalents of 1 ppb Rhodamine WT dye
<b>Resolution</b>	0.01 ppb
<b>Blue-green Algae</b>	
<b>Range</b>	100 to 2,000,000 cells/mL, 100 to 200,000 cells/mL, 100 to 20,000 cells/mL
<b>Accuracy</b>	± 3% for signal level equivalents of 1 ppb Rhodamine WT dye
<b>Resolution</b>	0.01 cells/mL





# Section 2 General Information

## 2.1 Safety Information

Please read this entire manual before unpacking, setting up, or operating this instrument.

Pay particular attention to all danger and caution statements. Failure to do so could result in serious injury to the operator or damage to the equipment.

Do not use or install this equipment in any manner other than that which is specified in this manual.

### 2.1.1 Use of Hazard Information

If multiple hazards exist, this manual will use the signal word (Danger, Caution, Note) corresponding to the greatest hazard.

#### **DANGER**

**Indicates a potentially or imminently hazardous situation which, if not avoided, could result in death or serious injury.**

#### **CAUTION**









**Indicates a potentially hazardous situation that may result in minor or moderate injury.**

**Important Note:** Information that requires special emphasis.

**Note:** Information that supplements main points in the text.

### 2.1.2 Precautionary Labels

Read all labels and tags attached to the instrument. Personal injury or damage to the instrument could occur if not observed.

	This symbol, when noted on the instrument, references the instruction manual for operation and/or safety information.
	This symbol, when noted on a product enclosure or barrier, indicates that a risk of electrical shock and/or electrocution exists and indicates that only individuals qualified to work with hazardous voltages should open the enclosure or remove the barrier.
	This symbol, when noted on the product, identifies the location of a fuse or current limiting device.
	This symbol, when noted on the product, indicates that the marked item can be hot and should not be touched without care.
	This symbol, when noted on the product, indicates the presence of devices sensitive to Electro-static Discharge and indicates that care must be taken to prevent damage to them.
	This symbol, when noted on the product, identifies a risk of chemical harm and indicates that only individuals qualified and trained to work with chemicals should handle chemicals or perform maintenance on chemical delivery systems associated with the equipment.
	This symbol, when noted on the product, indicates the need for protective eye wear.
	This symbol, when noted on the product, identifies the location of the connection for Protective Earth (ground).

## 2.2 DS5, DS5X Multiprobe

The DS5 and DS5X are designed for in-situ and flow-through applications, and can measure up to 15 parameters simultaneously. The DS5 and DS5X have seven configurable ports that can include up to ten of the following sensors: ambient light, ammonia, chloride, chlorophyll a, rhodamine WT, conductivity, depth, dissolved oxygen, nitrate, ORP, pH, temperature, total dissolved gas, turbidity, and blue-green algae.

**Figure 1 DS5 Multiprobe**

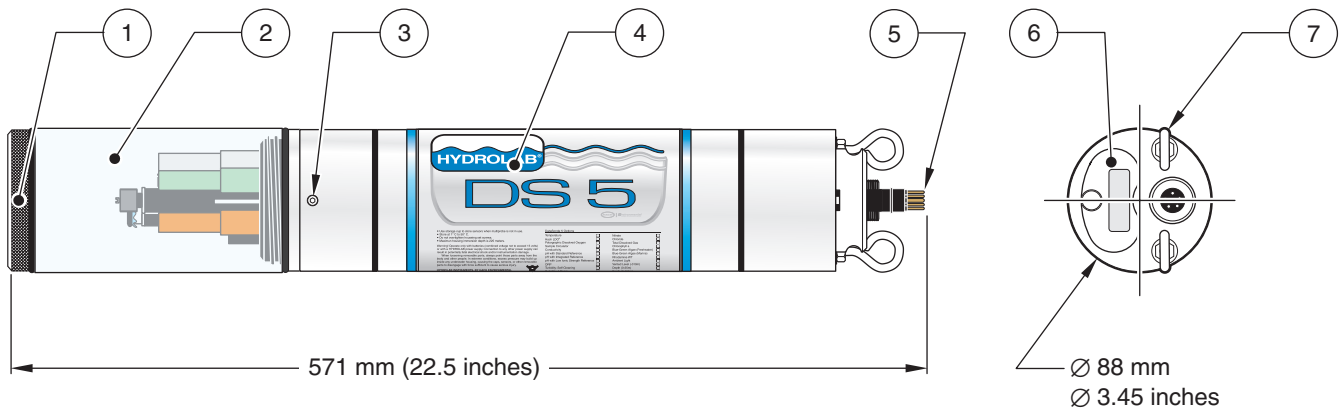

1. Calibration Cup	5. Bulkhead Connector
2. Storage Cup	6. Battery Compartment (optional)
3. Locking Screw	7. Bail Attachment
4. Housing	

**Figure 2 DS5X Multiprobe**

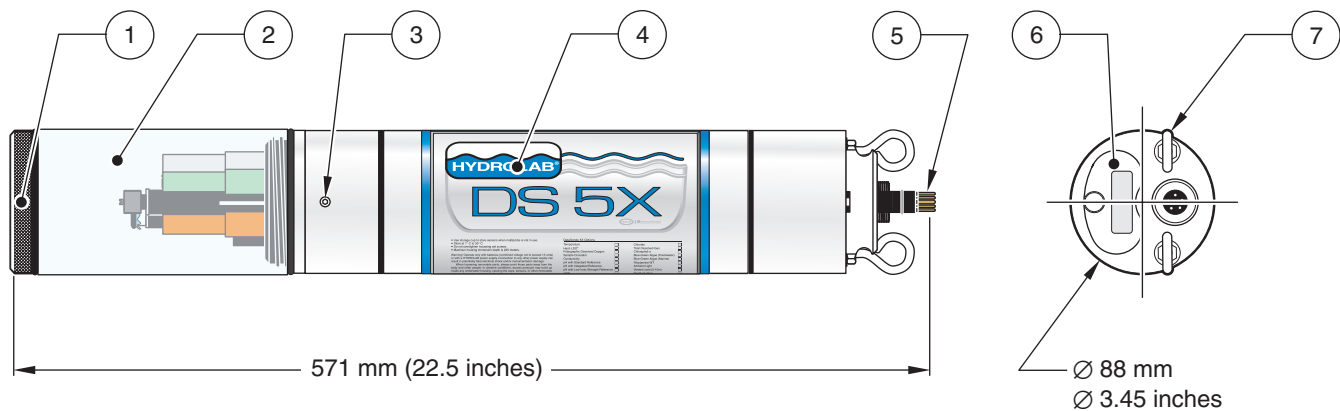

1. Calibration Cup	5. Bulkhead Connector
2. Storage Cup	6. Battery Compartment (optional)
3. Locking Screw	7. Bail Attachment
4. Housing	

## 2.3 MS5 Multiprobe

The MS5 is a portable instrument used for long-term monitoring or profiling applications. The MS5 has four configurable ports that can include a combination of the following sensors: ammonia, chloride, chlorophyll a, rhodamine WT, conductivity, depth, dissolved

oxygen, nitrate, ORP, pH, temperature, total dissolved gas, turbidity, and blue-green algae.

**Figure 3 MS5 Multiprobe**

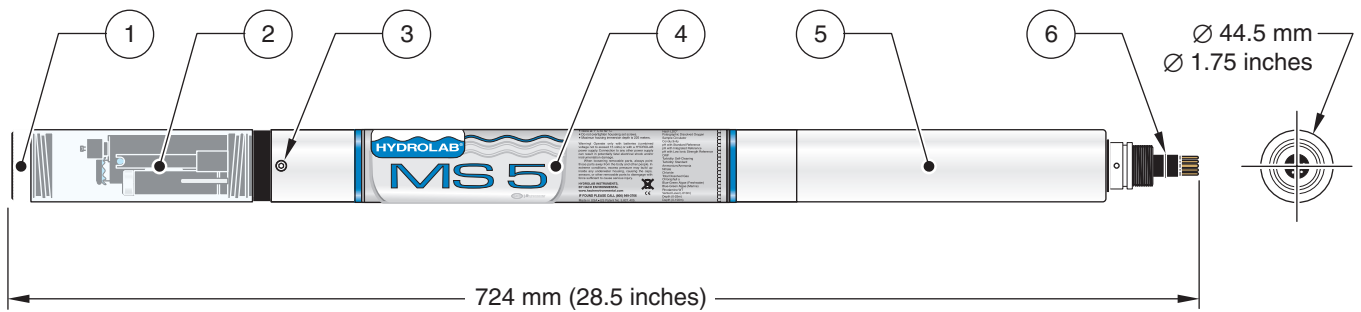



1. Calibration Cap	4. Housing
2. Calibration Cup	5. Battery Compartment (optional)
3. Locking Screw	6. Connector

## 2.4 Sensor Options





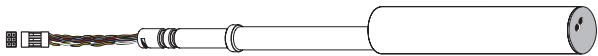

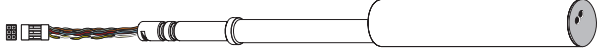

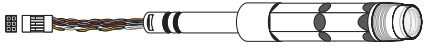

### MS5 Sensor Options

Sensor	Description	Cat. No.
	Hach LDO® Sensor	007455
	Clark Cell Dissolved Oxygen/Conductivity	004467
	Clark Cell Dissolved Oxygen	004470
	Conductivity with pH Return	004468
	Total Dissolved Gas	004469
	pH and ORP, with Integrated Reference	004454
	pH with Integrated Reference	004446
	Low Ionic Strength Reference	004445
	pH	004461
	pH and ORP	004462
	Chloride	004496
	Nitrate	004494
	Ammonium/Ammonia	004492
	Standard Reference	004463
	Circulator	007245
	Self-cleaning Turbidity	007280
	Standard Turbidity	004466

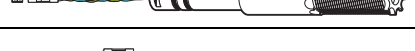
MS5 Sensor Options

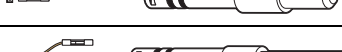
Sensor	Description	Cat. No.
	Chlorophyll a	007284
	Rhodamine WT	007285
	Blue-green Algae	007293

2.4.1 DS5 Sensor Options

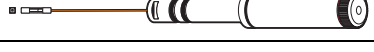
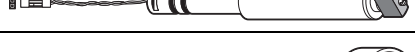
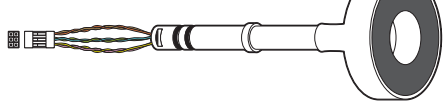
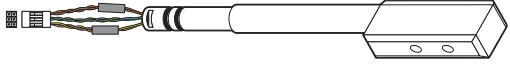
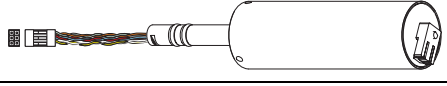
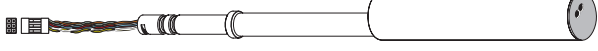
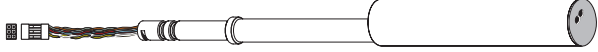
Sensor	Description	Cat. No.
	Hach LDO® Sensor	007455
	Clark Cell Dissolved Oxygen/Conductivity	004467
	Clark Cell Dissolved Oxygen	004470
	Conductivity with pH Return	004468
	Total Dissolved Gas	004469
	pH and ORP, with Integrated Reference	004454
	pH with Integrated Reference	004446
	Low Ionic Strength Reference	004445
	pH	004461
	pH and ORP	004462
	Chloride	004496
	Nitrate	004494
	Ammonium/Ammonia	004492
	Standard Reference	004463
	Circulator	007245
	4-beam Turbidity (DS5 only)	004524
	Standard Turbidity (DS5 only)	004466
	Self-cleaning Turbidity	007140
	Chlorophyll a	007202
	Rhodamine WT	007204

2.4.1 DS5 Sensor Options (continued)

Sensor	Description	Cat. No.
	Blue-green Algae	007291



## Section 3 Installation

---

### **DANGER**

**Only qualified personnel should conduct the tasks described in this section of the manual.**

### 3.1 Unpacking the Instrument

Remove the multiprobe from its shipping carton and inspect it for any visible damage. Contact Customer Service at 1-800-949-3766 if any items are missing or damaged.

*Note: It is normal for a small amount of solution to be in the cup.*

### 3.2 Instrument Assembly

There are many ways to connect a multiprobe to a display or a personal computer.

### **DANGER**

**An electrical shock hazard can exist in a wet or outdoor environment, if the multiprobe is powered via the external 115 VAC power supply. The safest and preferred method of powering this equipment in wet or outdoor environments is with battery or solar power (with a combined voltage not to exceed 15 volts). If it is necessary to power the multiprobe with the 115 VAC power supply in a wet or outdoor environment, a Ground Fault Interrupt (GFI) circuit is required. The installation of the GFI device must be done by a licensed electrician.**

1. Remove all protective plugs and keep them in a safe place, they will be used again for moving and storage.
2. Connect the calibration cable (Cat. No. 013470), or detachable cable (015XXX) to the multiprobe. The connectors are keyed for proper assembly. Align the bigger pin on the multiprobe male connector to the indicator dots on the female cable connector. Do not rotate the cable or force or twist the pins into the connectors to prevent damage to the connector pins.
3. Power the instrument by connecting the power receptacle from the calibration cable and external power adapter to an approved battery or power supply (see [Figure 4 on page 16](#)).
4. Connect the other end of the calibration cable, detachable cable, fixed cable, or external power adapter to the computer serial port.
5. Start the communications program (Hydras 3 LT).
6. The software will automatically scan for Sondes. All detected Sondes are displayed in the 'Connected Sondes' list in the Main window displayed below. If a Sonde is not found, reattach the data cable and press **RE-SCAN FOR SONDES**. Retry until the Sonde(s) are found.

### 3.3 Power Options

A logging multiprobe can be powered by several sources:

- The DS5 and DS5X have an optional internal battery pack (IBP) holding 8 size C alkaline batteries.
- The MS5 has an optional internal battery pack holding 8 size AA alkaline batteries.
- Both multiprobes can use the external battery pack (EBP).
- Both multiprobes can use either of the following power supplies: the 110 VAC 12 VDC power adapter or the 220 VAC 12 VDC power adapter.
- Both multiprobes can use a customer-supplied 12-volt deep cycle battery with appropriate amp-hour capacity connected via the battery adapter or a cable with a 4-pin female metal shell connector.
- Both multiprobes can be powered using a Surveyor Datalogging Display, which is equipped as a standard with a 7.2V, 3.5 Ah NiMH rechargeable battery.

**Note:** Multiprobes configured with the Self-cleaning Turbidity and one or more fluorescence sensors (Chlorophyll a, Rhodamine WT, Blue-green Algae) require either an internal battery pack or an external power source other than the Surveyor.

**Figure 4 Power Options**

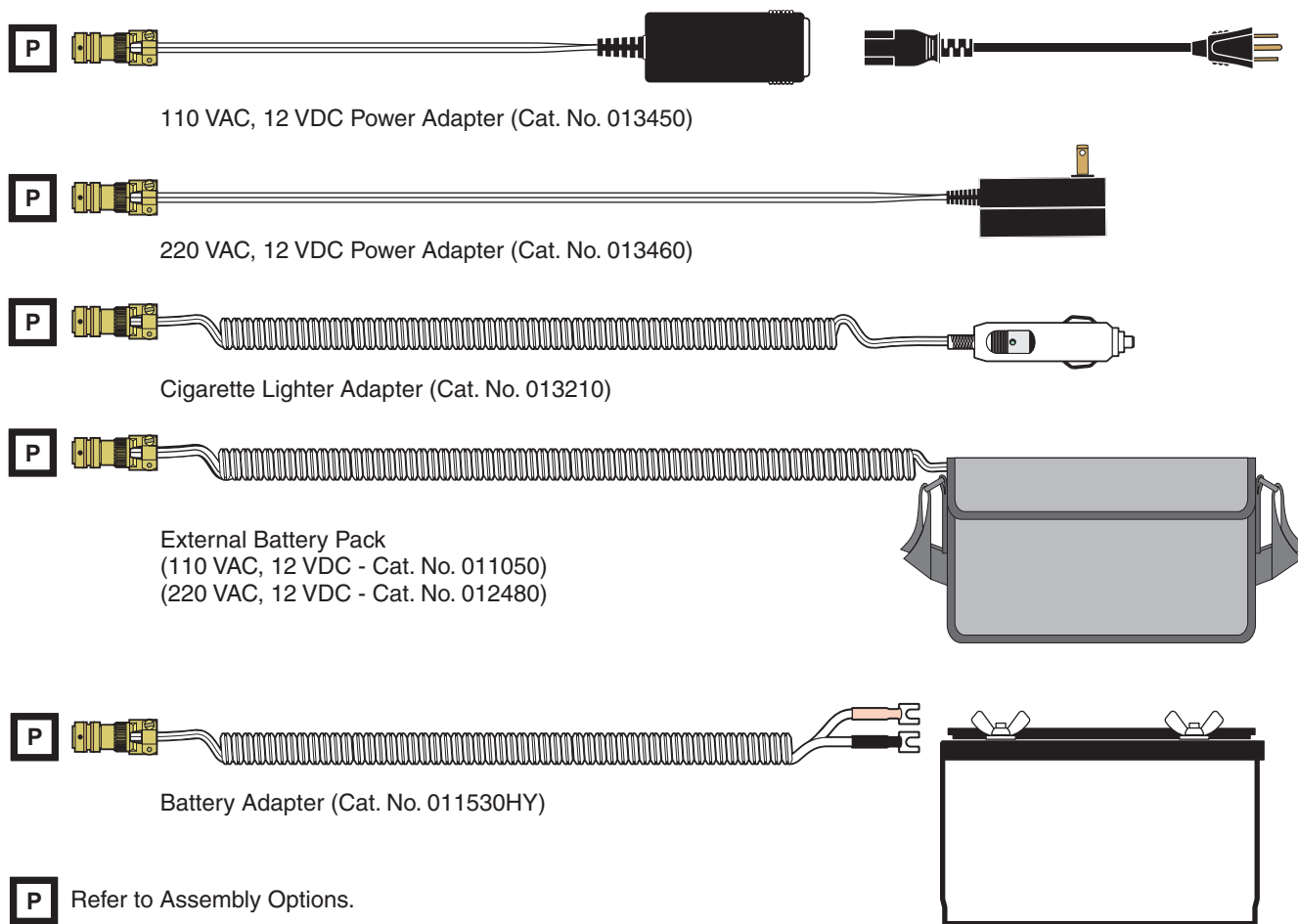

\*Use the correct power cord with the IEC 320 connector.

\*\*To prevent damage, use a regulated 12 VDC adapter. An unregulated 12 VDC adapter may exceed the instrument voltage limit rating.



Figure 5 Assembly Options

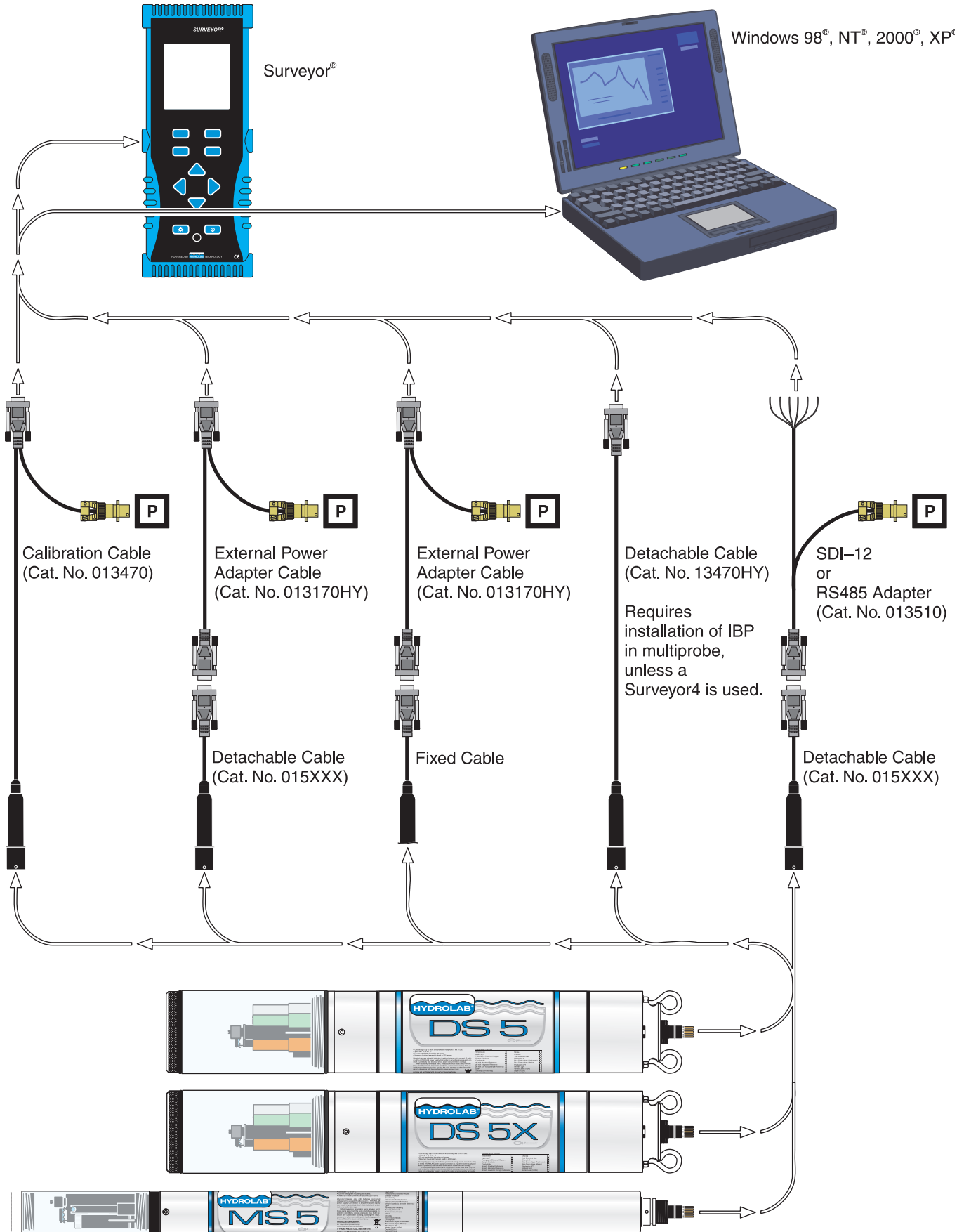

Refer to Power Options. **P**



## Section 4 Operation

### CAUTION

*When loosening removable parts from a multiprobe, always point those parts away from your body and other people. In extreme conditions, excess pressure may build-up inside any underwater housing, causing the caps, sensors, or other removable parts to disengage with force which may cause serious injury.*

The Sondes use Hydras 3 LT or a Surveyor to set up parameters and calibrate the sensors.

Figure 6 Operations Setup

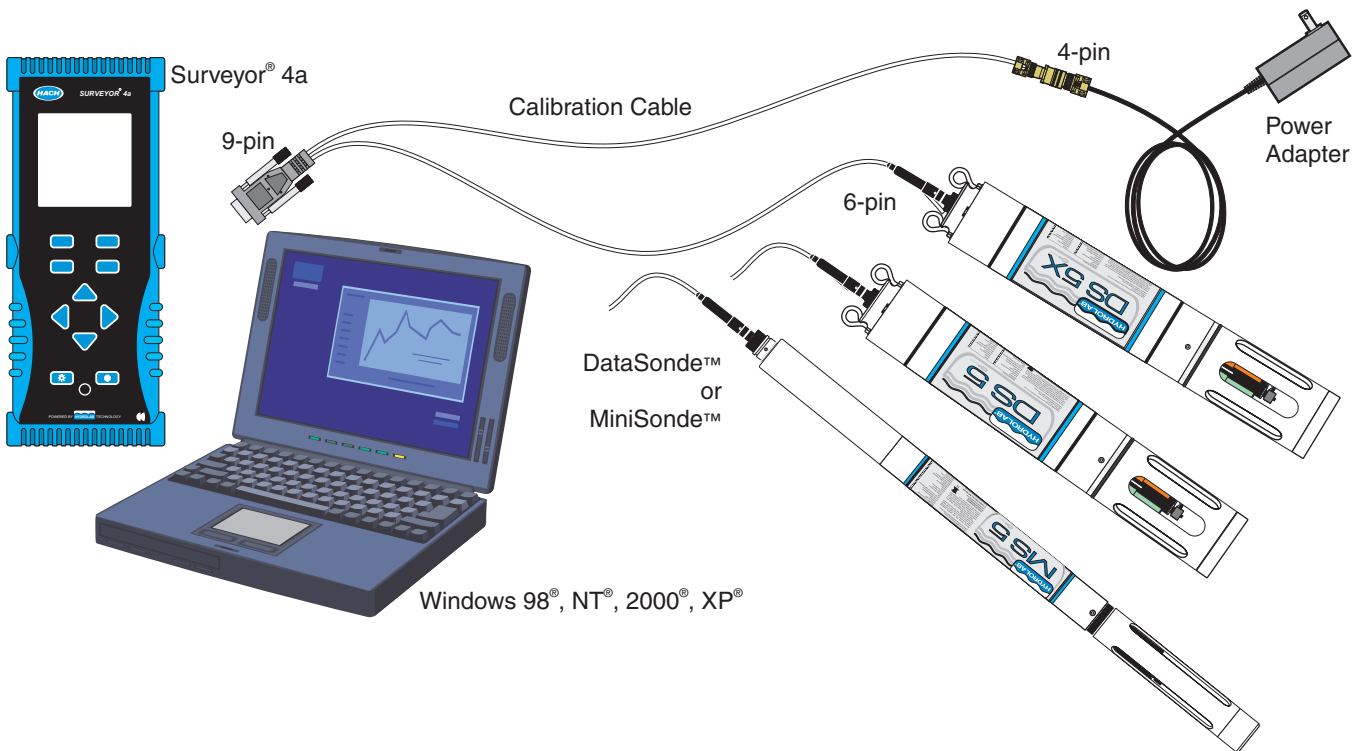

## 4.1 Parameter Setup

### 4.1.1 Using the Surveyor for Parameter Setup

For more information on the Surveyor, refer to the User Manual (Cat. No. 00719618).

1. Attach the power and data cable to the Sonde. Attach the 9-pin connector to the Surveyor.
2. Turn on the Surveyor. Wait approximately 10 seconds for initialization.
3. Press **SETUP/CAL**. Press **SETUP**. Press **SONDE**.
4. Highlight Parameters and press **SELECT**.
5. Use the **ARROW** keys to highlight the appropriate parameter and press **SELECT**.
6. Highlight the appropriate function and press **SELECT**. A configuration screen will be displayed. Depending on the application, use the **ARROW** keys to change the function, press **SELECT** and **DONE** to finish.

### 4.1.2 Using Hydras 3 LT for Parameter Setup

For more information on Hydras 3 LT, refer to the Quick Start Guide (Cat. No. 6234289) or press the **F1** key while Hydras 3 LT is active.

1. Attach the power and data cable to the Sonde. Attach the 9-pin connector to a PC.
2. Start Hydras 3 LT. Wait for the software to scan for connected Sondes. Highlight the multiprobe and press **OPERATE SONDE**.

**Note:** If the Sonde appears to be connected and the software does not recognize the Sonde connection, remove and replace the connector cable and press **RE-SCAN FOR SONDE**. Repeat until Hydras 3 LT recognizes the Sonde.

3. Click on the Parameter Setup tab and select the parameter tab to be configured.
4. Enter the appropriate values and press **SAVE SETTINGS**.

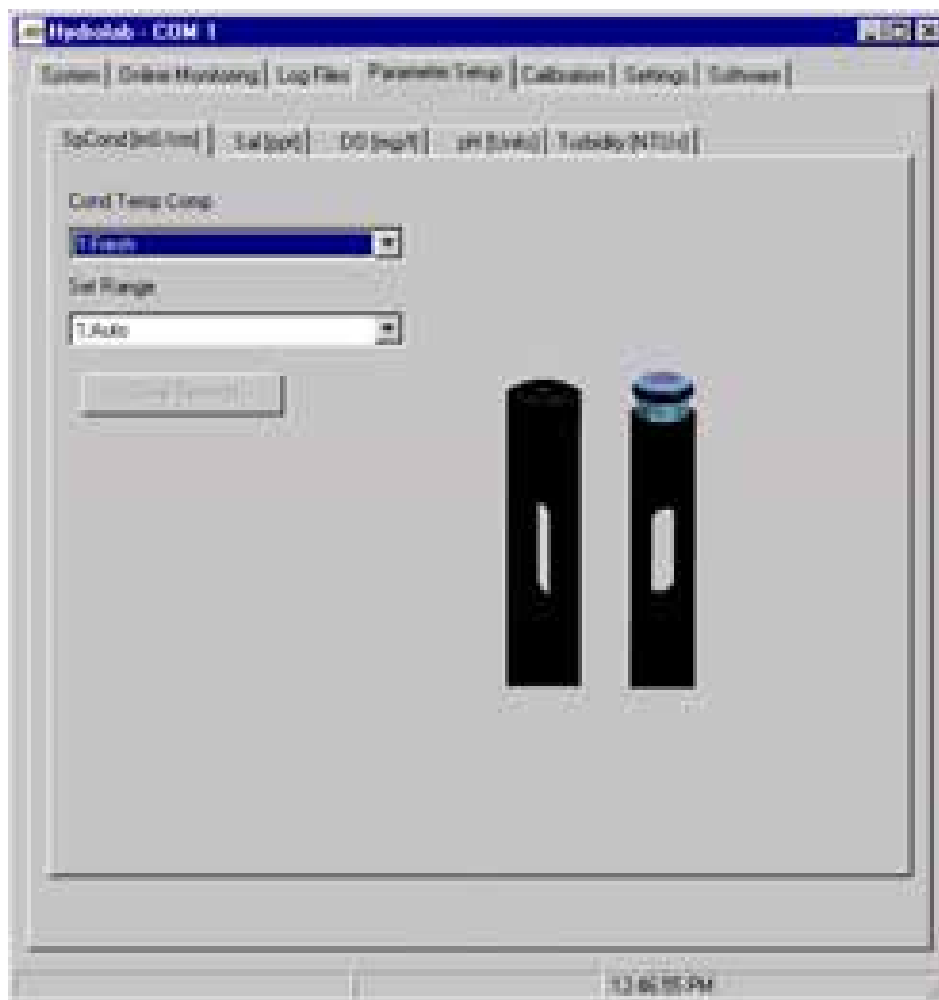

### 4.1.3 Specific Conductance Parameter Setup

For specific conductance set the following functions using Hydras 3 LT or the Surveyor:

- Select the specific conductance function (Fresh, Salt, StdMth, None, or Custom).
  - **Fresh** (default) is based on the manufacturer's freshwater temperature compensation. This function is derived from

$$0.01N \text{ KCl: } f(T) = c_1T^5 + c_2T^4 + c_3T^3 + c_4T^2 + c_5T + c_6,$$

where:

$$c_1 = 1.4326 \times 10^{-9}, c_2 = -6.0716 \times 10^{-8}, c_3 = -1.0665 \times 10^{-5}, c_5 = -5.3091 \times 10^{-2}, c_6 = 1.8199.$$

- **Salt** is based on the manufacturer's saltwater compensation.

$$f(T) = c_1T^7 + c_2T^6 + c_3T^5 + c_4T^4 + c_5T^3 + c_6T^2 + c_7T + c_8$$

where:

$$c_1 = 1.2813 \times 10^{-11}, c_2 = -2.2129 \times 10^{-9}, c_3 = 1.4771 \times 10^{-7}, c_4 = -4.6475 \times 10^{-6}, \\ c_5 = 5.6170 \times 10^{-5}, c_6 = 8.7699 \times 10^{-4}, c_7 = -6.1736 \times 10^{-2}, c_8 = 1.9524.$$

- **StdMth** will remove any temperature compensation, so the readings are equivalent to conductivity:  $f(T)=1$ .
- **Custom** will provide a compensation function that the user can define according to the following function:  

$$f(T) = aT^7 + bT^6 + cT^5 + dT^4 + eT^3 + fT^2 + gT + h.$$
- Select the Set Range (1:Auto, 2:High, 3:Mid, or 4:Low).
  - **Auto** (default) allows the multiprobe to automatically select the most appropriate range to measure conductivity. The multiprobe will dynamically change the range based on the current measurement conditions over 0–100 mS/cm. The resolution of the displayed data will also change to accommodate the current range in use.
  - **High, Mid, and Low** force the multiprobe to measure conductivity using a fixed range. If low range is selected, the readings will indicate an over-ranged condition for values above 1.5 mS/cm. The Mid range will over-range at 15 mS/cm. These choices also force the displayed readings to a fixed point or constant resolution format primarily only needed for certain SDI-12 data loggers. Otherwise, it is best to always select the Auto choice as this gives the best accuracy and performance for the conductivity sensor.
- Select the computation method for salinity (1:2311 or 2:StdMth).
  - **2311** (default): salinity is computed using an algorithm adapted from the United States Geological Survey Water-Supply Paper 2311 titled "Specific Conductance: Theoretical Considerations and Application to Analytical Quality Control". This salinity function is only defined from salinities in the 30 to 40 ppt range (mild concentrations and dilutions of sea water). This salinity function uses specific conductance values C in mS/cm compensated.

$$\text{Salinity} = c_1C^4 + c_2C^3 + c_3C^2 + c_4C + c_5$$

where:

$$c_1 = 5.9950 \times 10^{-8}, c_2 = -2.3120 \times 10^{-5}, c_3 = 3.4346 \times 10^{-3}, c_4 = 5.3532 \times 10^{-1}, \\ c_5 = -1.5494 \times 10^{-2}.$$

- **StdMth**: salinity will be computed using the Practical Salinity Scale (1978). This algorithm is defined for salinities ranging from 2 to 42 ppt and uses conductivity values corrected to 15 °C, regardless of the compensation function selected for specific conductance. This algorithm is described in section 2520B of "Standard Methods for the Examination of Water and Wastewater", 18th edition.

### 4.1.4 Clark Cell Dissolved Oxygen Parameter Setup

For dissolved oxygen, set the following functions using Hydras 3 LT or the Surveyor: Enable or Disable Salinity Compensation.

### 4.1.5 pH Parameter Setup

For pH, set the following functions using Hydras 3 LT or the Surveyor: Select either 2 or 3 calibration points.

### 4.1.6 Other Parameter Setup

Refer to the sensor specific instruction sheet for more information.

## 4.2 Calibration

**Sensors are checked for calibration before they leave the factory, however calibration needs to be specific for a site and application. Check the calibration prior to the first use.**

Calibrate the sensors when:

- Fouling has occurred or is noticeable (site-specific).
- Parameter measurements do not match those of a known calibrated standard.
- Adding or removing certain components for different applications (e.g., the circulator) or when replacing components (e.g., the Teflon junction of the pH reference electrode).

Some system components are affected by time, usage, and the environment. To ensure instrument accuracy, it is recommended to perform routine tests of the system under standard conditions. The multiprobe can be calibrated in the field or at a facility. Equipment checks and adjustment made before going to the field tend to be more precise than those made under field conditions.

### 4.2.1 Calibrating the Sensors Using the Surveyor

**For more information on the Surveyor, refer to the User Manual (Cat. No. 00719618).**

1. Attach the power and data cable to the Sonde. Attach the 9-pin connector to the Surveyor.
2. Turn on the Surveyor. Wait approximately 10 seconds for initialization.
3. Press **SETUP/CAL**. Press **CALIBRATION**. Press **SONDE**.
4. Use the **ARROW** keys to highlight the appropriate parameter and press **SELECT**.
5. Highlight the function to program and press **SELECT**. A calibration screen will be displayed. Depending on the application, use the **ARROW** keys to change the function, press **SELECT**, and **DONE** to finish the calibration.

## 4.2.2 Calibrating the Sensors Using Hydras 3 LT

For more information on Hydras 3 LT, refer to the Quick Start Guide (Cat. No. 6234289) or press the F1 key while Hydras 3 LT is active.

1. Attach the power and data cable to the Sonde. Attach the 9-pin connector to a PC.
2. Start Hydras 3 LT. Wait for the software to scan for connected Sondes. Highlight the multiprobe and press **OPERATE SONDE**.

**Note:** If the Sonde appears to be connected and the software does not recognize the Sonde connection, remove and replace the connector cable and press **RE-SCAN FOR SONDE**. Repeat until Hydras 3 LT recognizes the Sonde.

3. Click on the Calibration Tab and click on the parameter to be calibrated.
4. Enter the calibration values and click **CALIBRATE**.



## 4.2.3 Calibration Preparation

The following is a general outline of the steps required to calibrate all the sensors.

- Select a calibration standard whose value is near the field samples.
- Clean and prepare the sensors.
- To ensure accuracy of calibration, discard used calibration standards appropriately. Do not reuse calibration standards.

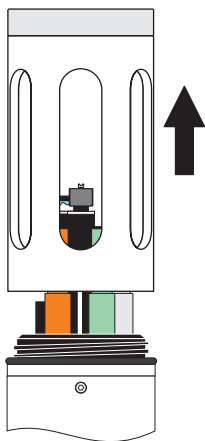

1. Remove Sensor Guard.

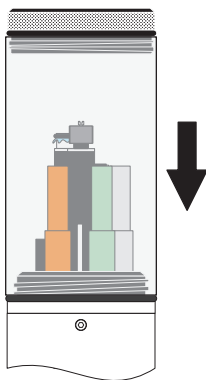

2. Attach the Calibration Cup.

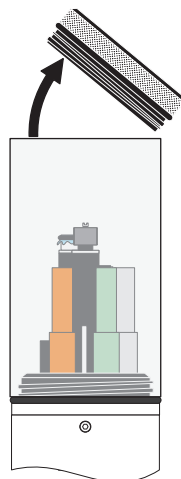

3. Unscrew and remove the cap from the Calibration Cup.

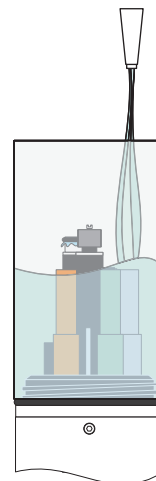

4. Fill the Calibration Cup half-full with deionized water.

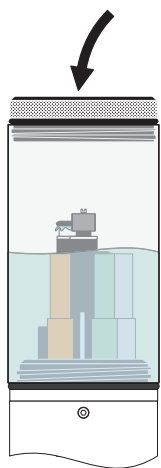

5. Place the Cap on the Calibration Cup.

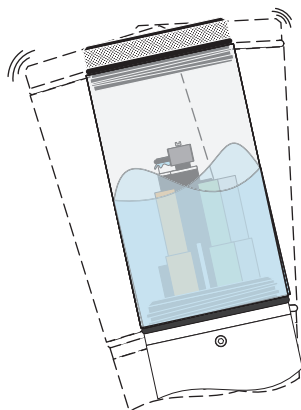

6. Shake the Sonde to make sure each sensor is free from contaminants that might alter the calibration standard. Repeat several times.

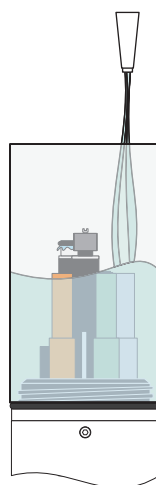

7. In a similar manner, rinse the sensors twice with a small portion of the calibration standard, each time discarding the rinse.

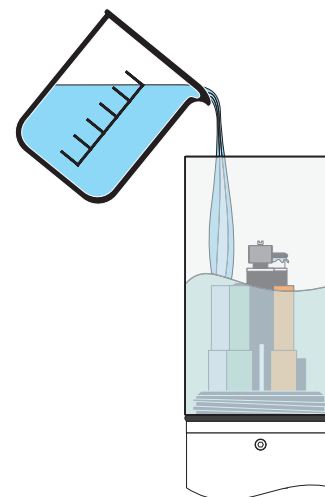

8. Complete the calibration.



## 4.2.4 Temperature Sensor Calibration

The temperature sensor is factory-set and does not require recalibration.

## 4.2.5 Specific Conductance Calibration

**Note:** TDS measurements are based on specific conductance and a user-defined scale factor. The factory default scale is 0.64 g/L / mS/cm.

This procedure calibrates TDS, raw Conductivity, and Salinity. Specific conductance requires a two-point calibration. Calibrate the sensor to zero and then to the slope buffer.

1. Pour the specific conductance standard to within a centimeter of the top of the Calibration Cup.
2. Make sure there are no bubbles in the measurement cell of the specific conductance sensor.
3. Enter the SpCond standard for mS/cm or  $\mu$ S/cm using Hydras 3 LT software or a Surveyor.

## 4.2.6 Clark Cell Dissolved Oxygen Sensor Calibration

Dissolved oxygen calibrations can be performed using water-saturated air or using a water sample with a known dissolved oxygen concentration.

**Note:** Dissolved oxygen can also be calibrated in a well stirred bucket of temperature-stable, air-saturated water. This situation resembles the actual field measurement conditions, but is more difficult to accomplish reliably.

### 4.2.6.1 Water-Saturated Air Dissolved Oxygen Calibration

#### **CAUTION**

**The saturated-air method is valid only for the Clark Cell dissolved oxygen sensor. If calibrating the Hach LDO sensor, refer to the Hach LDO Instruction Sheet (Cat. No. 00745589).**

**Note:** Calibration of D.O. % Saturation also calibrates D.O. mg/L.

1. Fill the Calibration Cup with deionized or tap water (specific conductance less than 0.5 mS/cm) until the water is just below the membrane O-ring. Do not allow water to contact the membrane or the O-ring.
2. Carefully remove any water droplets from the membrane with the corner of a tissue.
3. Turn the black cap upside down (concave upward) and lay it over the top of the Calibration Cup. This stops the exchange of air and allows the local environment to equilibrate. Wait for the reading to stabilize.
4. Determine the true barometric pressure for entry as the calibration standard. Barometric pressure information can be obtained from a local weather station or airport or the Surveyor (if equipped with BP). Some facilities calibrate BP at sea level, an elevation correction will need to be made.

**Local Barometric Pressure, BP, in mmHG can be estimated using:**

$$BP' = 760 - 2.5(A_{ft}/100) \quad \text{or} \quad BP' = 760 - 2.5(A_m/30.5)$$

where:

BP' = Barometric Pressure at altitude

BP = Barometric Pressure at sea level

A<sub>ft</sub> = Altitude in feet

A<sub>m</sub> = Altitude in meters

**If using the local weather bureau BP, remember these numbers are corrected to sea level. To calculate the uncorrected atmospheric pressure BP', use on the following equations:**

$$BP' = BP - 2.5(A_{ft}/100) \quad \text{or} \quad BP' = BP - 2.5(A_m/30.5)$$

where:

BP' = Barometric Pressure at altitude

BP = Barometric Pressure at sea level

A<sub>ft</sub> = Altitude in feet

A<sub>m</sub> = Altitude in meters

**Local barometric pressure in mbar (BPmbar) can be converted to local barometric pressure in mmHG (BPmmHg) using:**

$$BPmmHg = 0.75 \times BPmbar$$

5. Enter the barometric pressure in millimeters of Mercury (mmHg) at the site using Hydras 3 LT software or a Surveyor.

### 4.2.6.2 Known Concentration Dissolved Oxygen Calibration

**Note:** Calibration of D.O. mg/L also calibrates D.O. % Saturation.

1. Immerse the sensor in a water bath for which the D.O. concentration in mg/L is known (for instance, by Winkler titration). This calibration method is more difficult to perform than the saturated-air method but can yield a higher accuracy if the "known" D.O. concentration is highly accurate.
2. Enter the barometric units (mmHg) using Hydras 3 LT or a Surveyor.
3. Enter the D.O. units in mg/L using Hydras 3 LT or a Surveyor.

**Note:** If there is a change in barometric pressure after calibration (for instance, if barometric pressure drops as you move the calibrated Transmitter to a higher elevation for deployment), the readings for D.O. % Saturation will not be correct. You must enter a new barometric pressure. However, the readings for D.O. mg/L will be correct regardless of changes in barometric pressure.

## 4.2.7 Pressure Sensor Calibration

**Note:** The density of water varies with specific conductance. Pressure readings are corrected for specific conductance.

1. Remove water from the calibration cup.
2. Point sensors down.
3. Enter zero for the standard using Hydras 3 LT or a Surveyor.

## 4.2.8 pH/ORP Calibration

1. Pour the pH or ORP standard to within a centimeter of the top of the cup.
2. Enter the units for pH or ORP using Hydras 3 LT or a Surveyor.

**Note:** pH is a two-point or three-point calibration. A pH standard between 6.8 and 7.2 is treated as the “zero” and all other values are treated as the “slope”. First calibrate “zero”, then calibrate “slope”.

After the sensors have been properly maintained, the sensors can be calibrated. Always allow sufficient time for thermal stabilization of the standards. To reduce the time for stabilization, try to keep all calibration standards and equipment stored at the same temperature before parameter calibration. Always use fresh standard and do not tamper with standards.

## 4.2.9 Other Sensor Calibrations

Refer to the sensor specific instruction sheet for more information.

## 4.3 Using the DS5/MS5 for Short Term Deployments

### 4.3.1 Gathering Data Using the Surveyor

Refer to the Surveyor Manual (Cat. No. 003070).

### 4.3.2 Gathering Data Using a PC and Hydras 3 LT

For online monitoring and real-time monitoring information, refer to the Hydras 3 LT Quick Start Guide (Cat. No. 6234289).

### 4.3.3 Using the DS5/DS5X/MS5 for Unattended Monitoring

#### 4.3.3.1 Creating Log Files

**Note:** A log file must be created and then enabled before data can be collected.

1. Connect the Data Cable to a computer and to the Sonde.
2. Start Hydras 3 LT. The software will automatically scan for Sondes. All detected Sondes are displayed in the ‘Connected Sondes’ list in the Main window displayed below. If a Sonde is not found, reattach the data cable and press **RE-SCAN FOR SONDES**. Retry until the Sonde(s) are found.
3. Click on the Log Files tab.
4. Click the **CREATE** button.

5. Enter the name for the new log file. The empty log file is now created.
6. Enter the start and end time of the logging, the logging interval, the sensor warm-up time before logging, and how long before logging the circulator will be turned on, and if audio signals will be used while logging.
7. Select the parameters in the 'Parameter in Sonde' list and click the **ADD** button to place them into the 'Parameters in log file' list. Change the order of the parameters using the **ARROW** buttons.
8. Click **UPDATE SETTING** to send the configuration to the Sonde.
9. Click **ENABLE** to start collecting data. Click **DISABLE** to stop collecting data during logging. A fully completed logging run will automatically disable at the end of the run.
10. Click **DOWNLOAD** to download and display the log file. Select Printable or Spreadsheet format.

*Note: To delete a log file, select the log file in the Log File drop-down menu and click the **DELETE** button.*

### 4.3.3.2 Downloading Log Files

After a log file is created in the Log Files tab, the files can be downloaded by checking the appropriate Log File box and clicking **DOWNLOAD SELECTED FILES**. Multiple files can be downloaded at once. The downloaded log files are stored in the 'LogFiles' subdirectory of the HYDRAS 3 LT directory on the hard drive.

# Section 5 Deployment

---

## 5.1 Deployment Considerations

### 5.1.1 Pressure Extremes

**Note:** The multiprobe maximum immersion depth is 225 meters (738 feet).

**Note:** The ion specific sensors (Nitrate, Ammonia, and Chloride) maximum deployment depth is 15 meters.

**Important Note:** The 0–10 meter vented depth sensor should be protected from depths over 15 meters (49 feet) by installing the seal screw (provided in the basic maintenance kit) in the face of the multiprobe sensor cap. Likewise, the 0–25 depth sensor should be protected from depths over 35 meters (164 feet) by installing the same seal screw. However, the 100- and 200-meter depth sensors do not require installation of the seal screw.

The multiprobe may be equipped with one of the following depth options: 0–10 meters (33 feet), 0 to 25, 0 to 100, and 0 to 200 meters (82, 328, and 656 feet). The first option is used to detect water level changes that are automatically compensated for barometric pressure changes. Applications include tidal waters, rivers, stream, lakes, reservoirs, and groundwater. The vented level option must have a fixed cable with a vent tube. The second, third, and fourth options are usually used to determine the depth in the water column at which the other parameter readings are made.

### 5.1.2 Temperature Extremes

The multiprobe storage temperature range is 1 to 50 °C (34 to 122 °F), non-freezing, when going or coming back from a deployment site, or when storing the multiprobe.

The multiprobe operating temperature range is –5 to 50 °C (23 to 122 °F), non-freezing. Exposing the multiprobe to temperatures outside this range may result in mechanical damage or faulty electronic performance.

To prevent sensors from freezing, store the multiprobe where freezing will not occur. To prevent the sensors from dehydrating, fill the DS storage cup or MS cup with one inch of clean tap water.

Always rinse the multiprobe with clean tap water after deployment.

### 5.1.3 Data Transmission Lines

When adding a transmission cable to the multiprobe, the cable must be large enough to carry the operating current and transfer data without distortion. For up to a total of 305 m (1000 ft) of cable, three 26 AWG wires are suitable for data transmission, but two 18 AWG must be used for the power wires. Alternatively, smaller power wires can be used if the power supply is placed closer to the multiprobe. A cable extension kit is available for above-ground applications ([Replacement Parts and Accessories on page 47](#)).

### 5.1.4 Minimum Depth Requirements

Sensors must be immersed. The Standard Turbidity Sensor minimum deployment depth is 1 meter.

## 5.2 Deployment in Open Waters

### 5.2.1 Minimum Clearance Requirements

Two inches of clearance is required from the longest probe and two inches around if a Turbidity sensor is supplied.

### 5.2.2 Long-term Deployment in Open Waters

**Important Note:** The use of pipe clamps to secure the Sonde can cause serious instrument damage.

When using the multiprobe in open water, place the multiprobe where it will not get damaged. For example, to protect the multiprobe from being hit by floating debris in moderate-to high-flow levels, anchor the multiprobe to the downstream side of a bridge piling (Figure 7). The protection kit can also be used to protect the multiprobe. In a recreational lake deployment, use a marking buoy that will not attract vandalism.

Place the multiprobe in an upright or on-side position, and avoid areas with deposits of sand, gravel, or silt during heavy rainfall. Avoid deploying in location where ice will form around the sensors or Sonde.

Figure 7 Securing the Multiprobe to a Structure

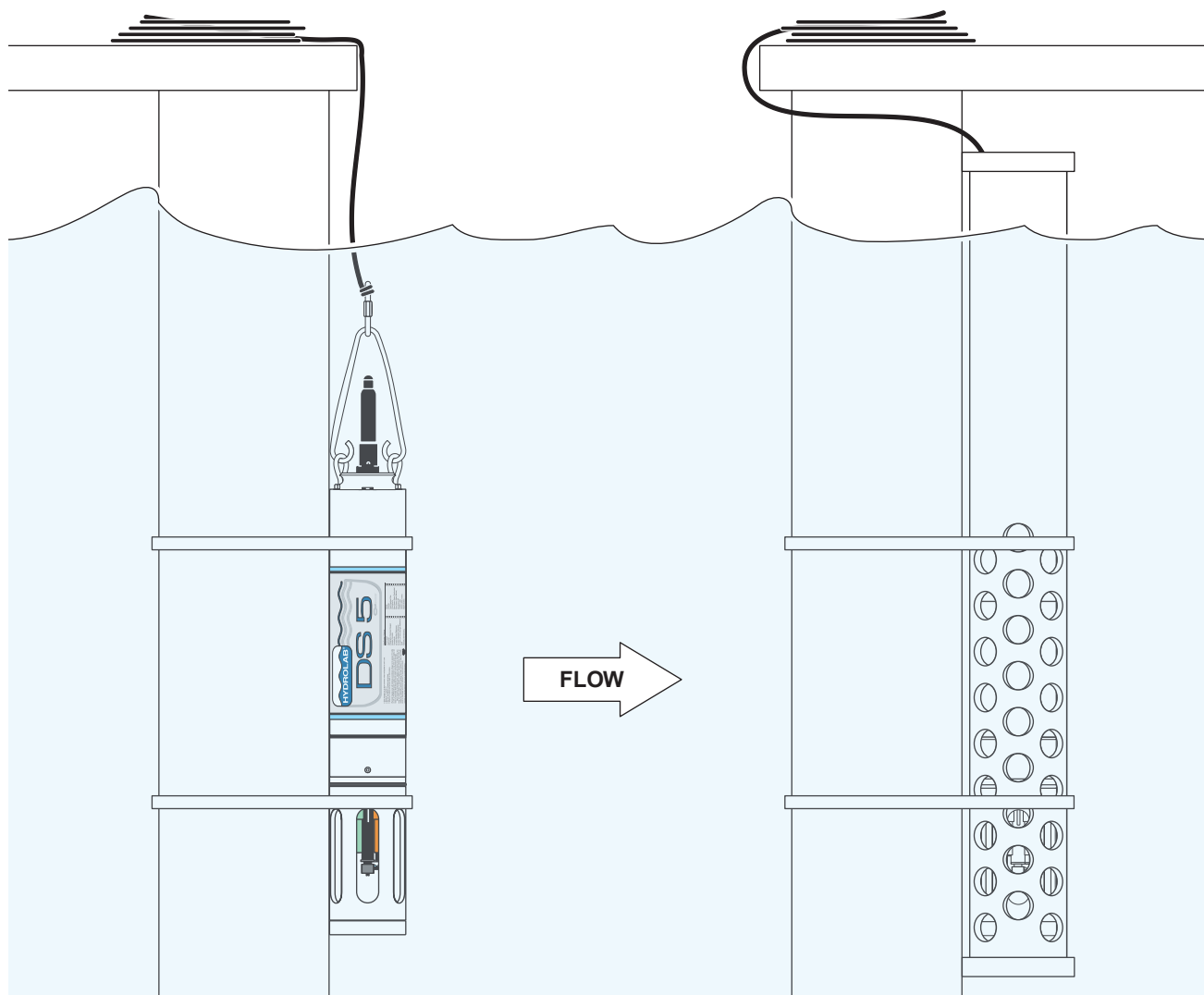

When securing the multiprobe to a structure, carefully place straps such as web belts and large plastic Ty-wraps on both ends of the multiprobe housing (Figure 7). Do not use clamps to secure the multiprobe to a structure. Also, secure the cable in the same manner to protect it from floating debris, navigation, and vandalism.

Always make sure the weighted sensor guard is installed to protect the sensors and provide additional sinking weight to the multiprobe.

Calibration stability is dependent on the environmental conditions in which the sonde is deployed. For example, a D.O. sensor on a DS5 or MS5 may become fouled if deployed in a warm, shallow, biologically active lake. However, deployment length can be increased by a factor of 5 by using a DS5X which periodically cleans the fouling from the sensors. On the other hand, the same sonde deployed in a clean water environment, or a sonde configured with sensors impervious to fouling (i.e., Temperature, Conductivity) can be left unattended for months without the need to recalibrate. Optimal deployment time for a specific environment can be determined by making periodic measurements of sensitive parameters with another instrument.

### 5.2.2.1 Anchoring the DS5 or DS5X using the Support Bail

1. Run a rope or chain through the bail, if the Sonde is equipped with a support bail.
2. Fix the bail into the two eye bolts on the top of the Sonde by first loosening the lock-nuts and turning the eye bolt 90°, and then back, so that the bail can be looped through.
3. Securely tighten the lock-nut on each eye bolt. If the multiprobe is not equipped with internal batteries, it may not have a bail but can be secured using the locking sleeve.

**Figure 8 DS5 Support Bail Installation**

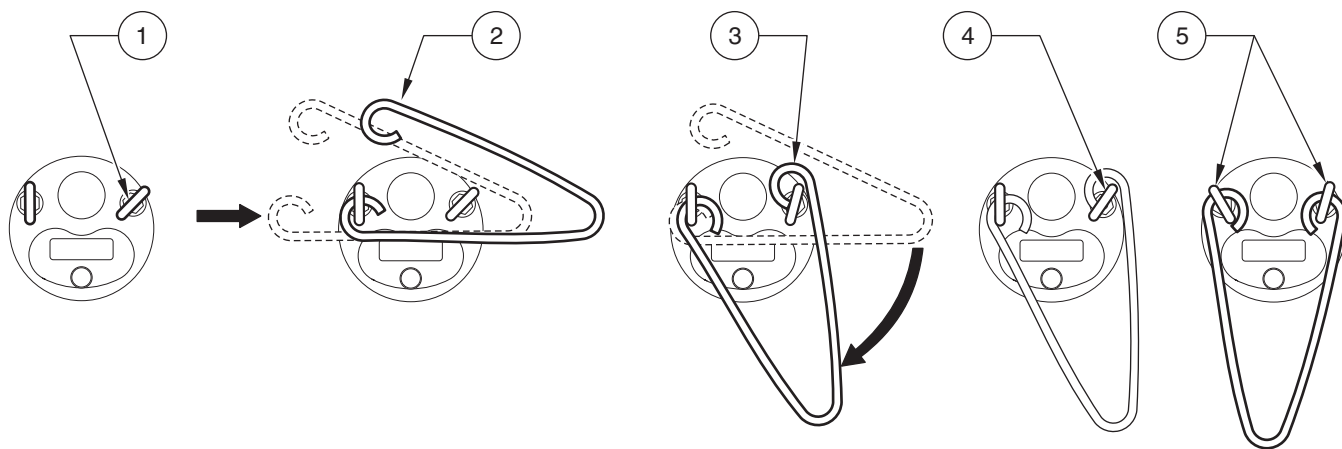

1. Turn the eye bolts to the positions shown.	4. Rotate the eye bolt around the bail as shown.
2. Hook the bail into the eye bolt as shown.	5. Finish rotating the eye bolts until the bail cannot be removed.
3. Rotate the bail into the other eye bolt as shown.	

5.2.2.2 Anchoring the MS5 using the Bail Kit

Figure 9 MS5 Support Bail Installation

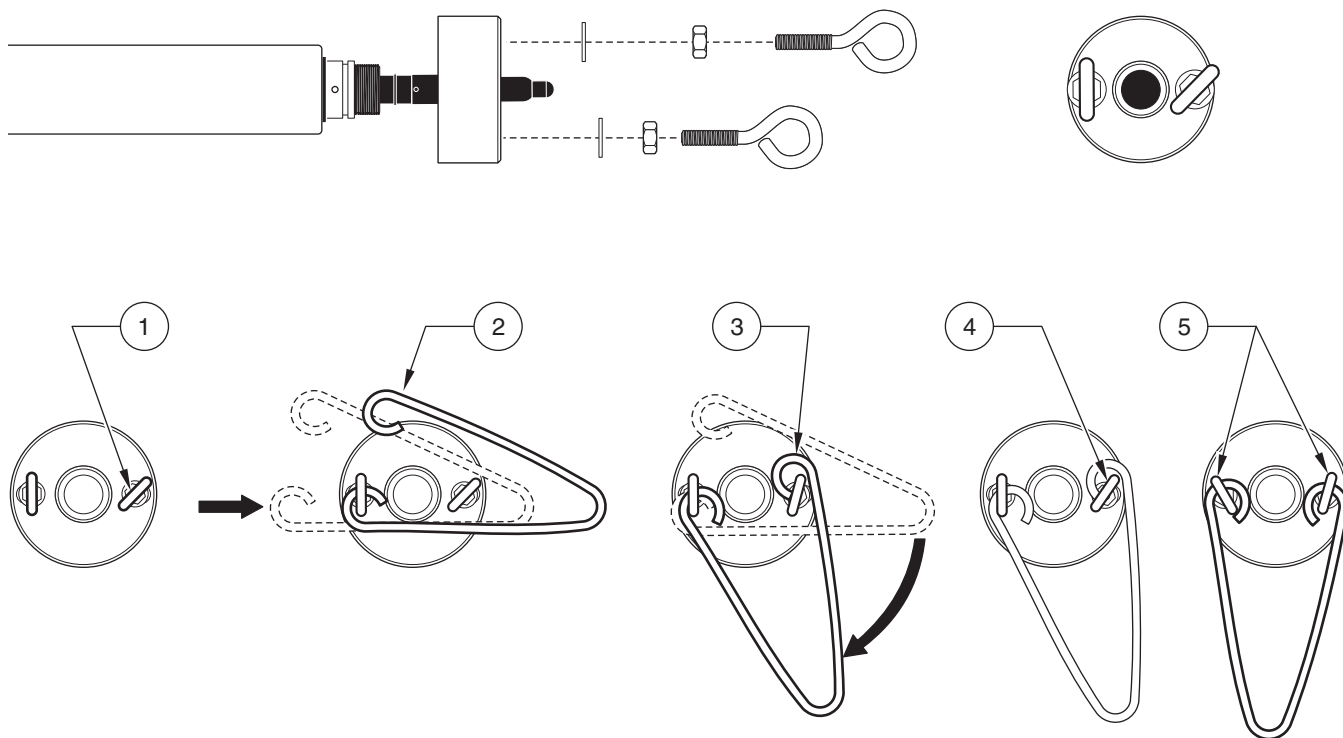

1. Turn the eye bolts to the positions shown.	4. Rotate the eye bolt around the bail as shown.
2. Hook the bail into the eye bolt as shown.	5. Finish rotating the eye bolts until the bail cannot be removed.
3. Rotate the bail into the other eye bolt as shown.	

5.2.2.3 Anchoring the MS5 using the Mooring Fixture

A MS5 equipped with an internal battery pack requires the MS5 mooring fixture which screws onto the multiprobe bulkhead connector and provides an eyelet for rope or wire when no cable is used during deployment.

Figure 10 MS5 Mooring Fixture

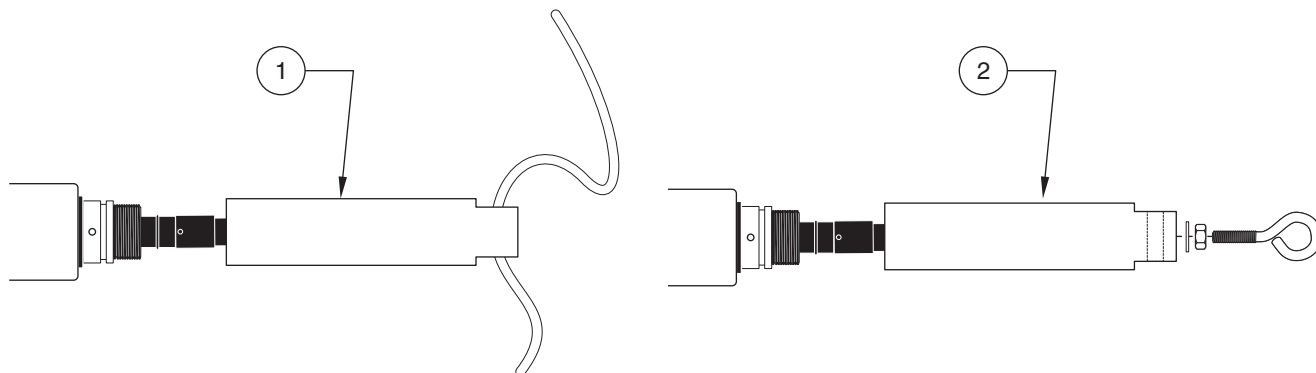

1. Mooring fixture used with rope or chain.	2. Mooring fixture used with eye bolt.
---	--



### 5.2.3 Short-term Deployment in Open Waters

Generally, short-term deployment implies hand-held operation.

**Important Note:** Do not pull Sonde from a moving boat or instrument damage may occur and voids the instrument warranty.

- Do not lower the multiprobe into the water without screwing on the weighted sensor guard.
- Secure the underwater cable prior to deployment.
- Do not place the instrument where the cable might be severed or damage by boat propellers or any moving parts on a monitoring system.
- Protect all cables from abrasion, unnecessary tension, repetitive flexure, or bending over sharp radii (boat gunwale or a bridge railing).
- Do not bend or run the cable over the sheave or pulleys with less than 3-inch radius or 6 inches in diameter.
- Use the V-shaped support bail to lift and lower the multiprobe, if so equipped. This ensures that the weight of the multiprobe is suspended from the bail. If the multiprobe is equipped with a locking sleeve instead of a support bail, make sure the locking sleeve or the MSS mooring fixture are properly screwed on the multiprobe 6-pin marine bulkhead connector before deployment.
- Extra weight, up to 5 kg (10 lb) maximum, can be attached to the Sonde (Figure 11). If more weight is needed, use a wire line to support the instrument by its bail, if so equipped.
- Use a battery-powered or hand-cranked reel with electrical slip-rings to lower and raise the instrument, if the cables are very long. A lighter reel without slip-rings for shorter cables can also be used (Figure 12).
- If sufficient deck space permits, mount the reel horizontally with the instrument and a battery installed in the hub (Figure 12). The manufacturer's cable reel can also be used to store up to 150 m (490 ft) of underwater cable (the reel must be ordered with the initial underwater cable purchase).
- In deep deployments currents, in conjunction with the sensor guard, can put extreme strains on the cabling.

**Figure 11** Using the Weighted Sensor Guard

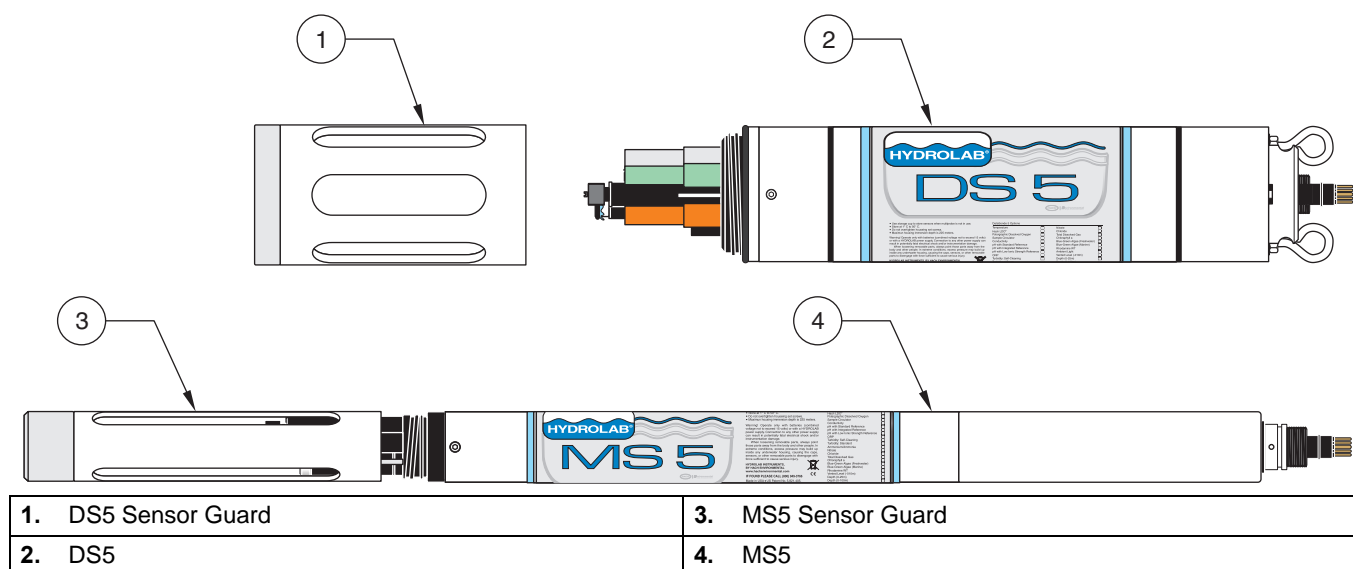
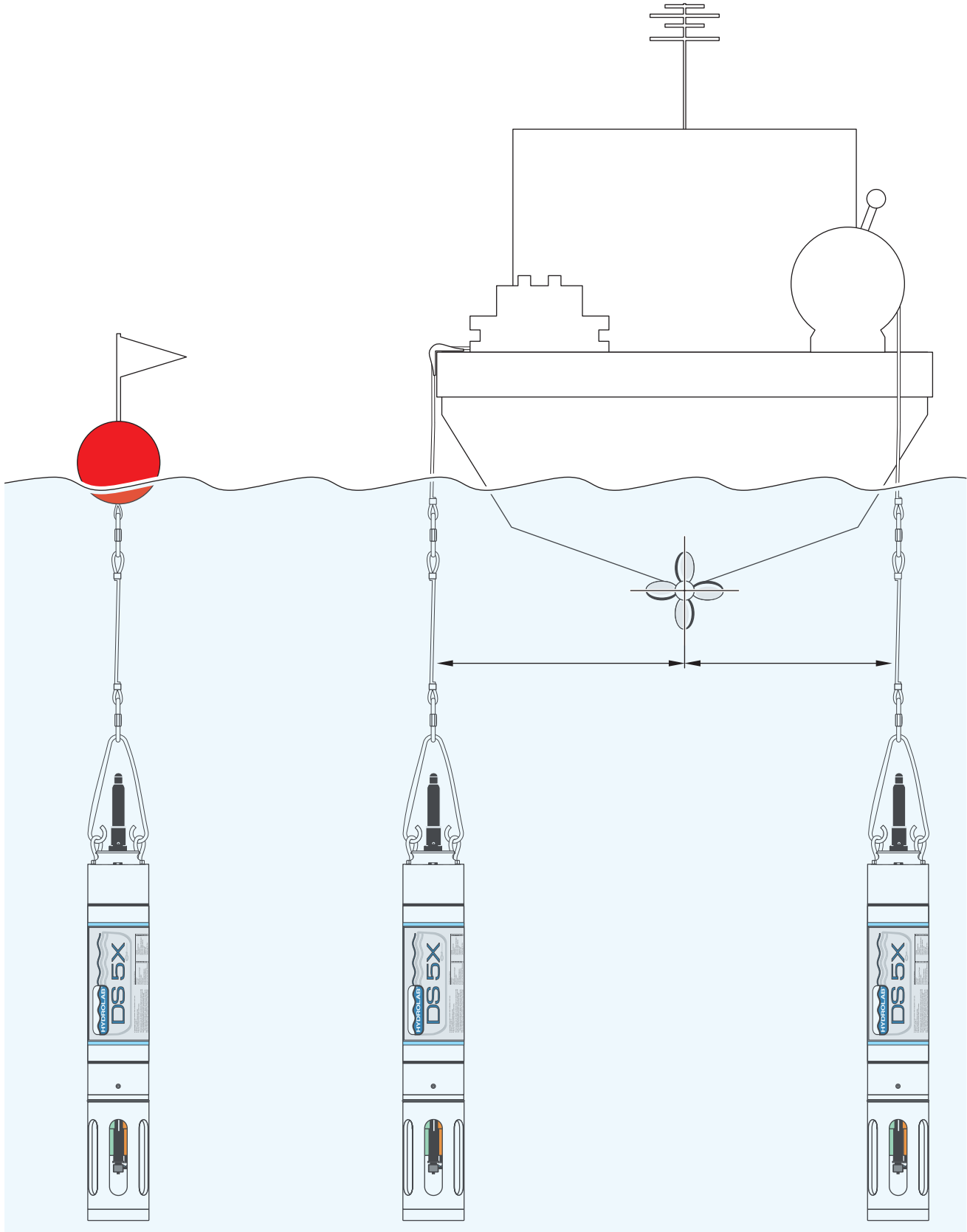

Figure 12 Open Water Deployment



## 5.2.4 Minimum Flow Requirements

When deploying the multiprobe in waters flowing at less than one foot per second (0.333 mps), a circulator option may be used for additional flow in order to achieve reliable Clark Cell dissolved oxygen sensor readings. The circulator is activated via Hydras 3 LT software or the Surveyor.

Turning the circulator on or off will help during profiling and logging D.O. with a Clark Cell Sensor, depending on the flow rate of the water at the site. If insufficient flow rate is noticeable, turn the circulator on. Turn the circulator off to extend battery life when data is not needed for an extended period of time. Turn the circulator on when logging data in unattended mode and need to have sufficient flow for accurate measurements, note that this will reduce multiprobe battery life.

When the multiprobe is powered, it takes time to warm-up. The warm-up time refers to the time a sensor will be ready to record accurate data. Warm-up time will vary according to the sensors being used and field conditions (e.g. temperature).

## 5.2.5 Non-submersible Deployment

### ***DANGER***

***Do not let the flow cell pressure exceed 15 psig. Higher pressure can burst the flow cell, possibly causing serious bodily injury to oneself and/or others.***

For process or pump-through situations, attach the low-pressure flow-cell to the multiprobe. This configuration allows studying the water without submerging the multiprobe. The flow cell replaces the DS storage cup or MS cup ([Figure 13](#)). When measuring D.O. with a Clark Cell Sensor inside a flow cell, the manufacturer recommends using a circulator in conjunction with the sensor. For use without a circulator, use a flow rate of more than 4 liters per minute. A ½-inch hose is required for the MS flow cell and a ¾-inch hose for the DS flow cell.

Filter debris from the feed line, if necessary. If possible, invert the multiprobe, so that bubbles will float away from the sensors and out the port on the bottom of the flow cell.

**Figure 13** Flow Cells

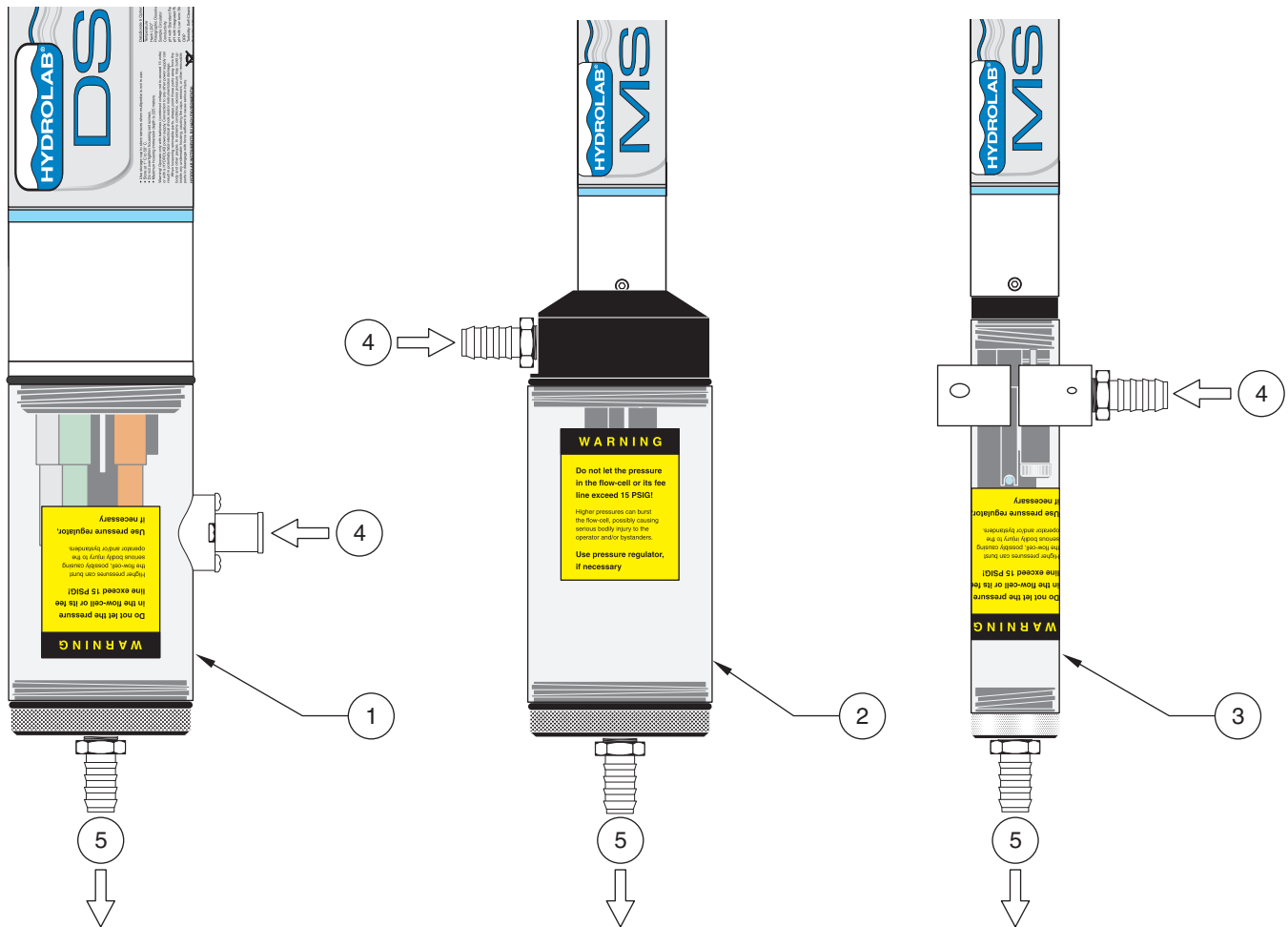

1. DS flow cell	4. Sample flow IN
2. MS flow cell (with standard turbidity sensor)	5. Sample flow OUT
3. MS flow cell	

### **DANGER**

**Only qualified personnel should conduct the maintenance tasks described in this section of the manual.**

To ensure continued and reliable operation of the water quality monitoring system, we recommend scheduling a thorough and regular maintenance program. To determine the appropriate maintenance intervals required for a deployment site, periodically conduct a visual inspection of the equipment and sensors, compare the pre- and post-calibration results, and monitor the sensor response time.

A contaminated, worn-out, or damaged sensor will not produce reliable readings. It is recommended to service all sensors and allow them to equilibrate in tap water overnight before calibration.

Maintenance kits are available for the DS5, DS5X, and MS5. See [Replacement Parts and Accessories on page 47](#).

## 6.1 Multiprobe and Accessory Maintenance

### 6.1.1 Cleaning the Multiprobe Housing

Clean the outside of the multiprobe housing using a clean brush, soap, and water. Always use the DS storage cup or the MS cup (filled with one inch of tap water) to protect the sensors from damage, and especially from drying out, whenever the multiprobe is not deployed.

Do not expose equipment to extreme temperatures below 1 °C (34 °F) or above 50 °C (122 °F).

Always rinse the multiprobe with clean tap water soon after returning from deployment.

### 6.1.2 Dryer Maintenance

**Important Note:** *Do not submerge the dryer in water.*

The in-line vented level dryer is a part of the cable and penetrator assembly, if the Sonde has the vented depth sensor (0–10 meters).

The GORE-TEX® patch (round patch on dryer) allows gases to come into the dryer and is splash proof, but not submersible. Any water leaks inside the dryer can block the tube which goes into the multiprobe. If water leaks are detected, contact Technical Support.

The dryer contains desiccant bag(s) (white bag) to keep condensation from forming inside the vented tube which goes from the dryer to the multiprobe. If moisture is detected inside the dryer, replace the bags ([Figure 14](#)).

To replace the desiccant bag(s):

1. Unscrew both dryer nuts and unscrew the dryer cap.
2. Inspect the indicator strip. If the stripe is dark blue, the bag does not need replacement. If the stripe is light pink or purple, remove, discard, and replace the old bag.
3. Reassemble the dryer.

**Figure 14 Dryer Maintenance**

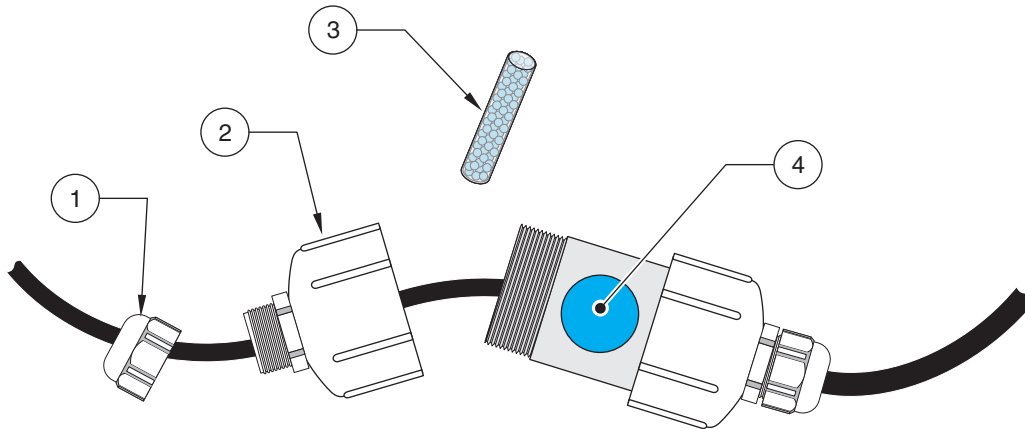

1. Dryer Nuts (2)	3. Desiccate Packet
2. Dryer Cap	4. Gore-tex Patch

### 6.1.3 FreshFlow™ Miniature Sample Circulator Maintenance

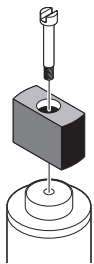

1. If the circulator is clogged with twigs or other small debris, clean the impeller with some tap water using a soft bristle brush. Use a pair of plastic tweezers to help remove debris. Rinse with tap water.
2. If there is excessive build-up on the impeller, remove the retaining screw to clean the build-up. After cleaning the impeller, and before inserting the retaining screw, apply a very small amount of Loctite™ 242 threadlock (or equivalent) on the tip of the screw. Do not overtighten.

## 6.2 Battery Replacement

If the multiprobe is equipped with an internal battery pack, the following batteries are customer-replaceable. The Sondes are also equipped with a customer-replaceable Lithium clock battery.

- 8 size C alkaline batteries for the DS5 and DS5X
- 8 size AA alkaline batteries for the MS5

**Important Note:** To keep internal components dry, avoid replacing batteries near a water source.

**Important Note:** If water leaks into the multiprobe battery compartment, remove the batteries, pour the water out, and thoroughly dry the compartment with a towel.

### 6.2.1 DS5 and DS5X Battery Replacement

**DANGER**

**If the thumbscrew is difficult to remove, there may be pressure built up inside the housing. To avoid serious injury, use extreme caution when loosening the battery cap thumbscrew.**

**DANGER**

**Batteries must be installed in the correct orientation or serious injury and instrument damage may occur. Do not mix depleted and fresh batteries together or serious injury and instrument damage may occur.**

Use only high quality, non-rechargeable batteries in the DS5 or DS5X multiprobe. Refer to [Figure 15](#) and the following directions for DS5 and DS5X battery replacement.

1. Set the multiprobe horizontally on the work surface to prevent water leaking into the multiprobe battery compartment.
2. Unscrew the battery cap thumbscrew, counterclockwise.
3. Pull the cap out of its housing and slide the old batteries out.
4. Discard the old batteries. Insert the new batteries, **observing polarity markings located on the inside label**. Failure to install the batteries in the correct orientation may cause serious injury and instrument damage.
5. Coat the battery cap O-rings sparingly with silicone grease. Insert the cap back into the multiprobe housing. Tighten the thumbscrew, clockwise. Finger-tighten only.

**Figure 15 DS5 and DS5X Battery Replacement**

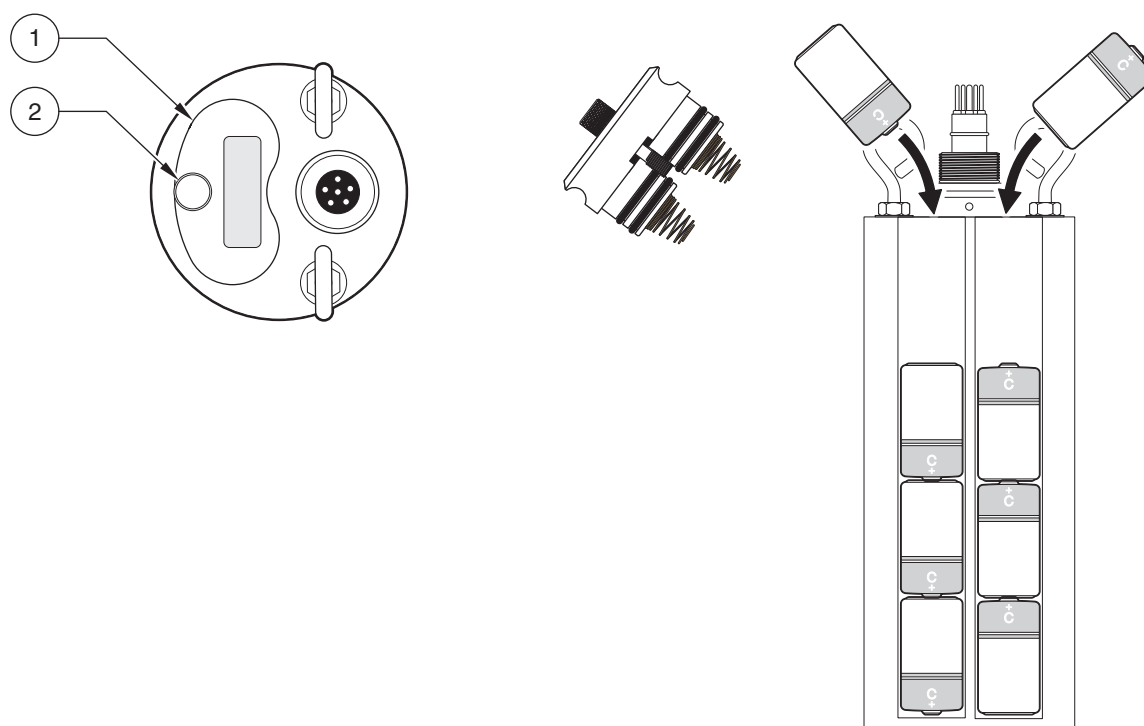

1. Battery Cap

2. Battery Cap Screw

### 6.2.2 MS5 Battery Replacement

**DANGER**

**Batteries must be installed in the correct orientation or serious injury and instrument damage may occur.**

**DANGER**

**Do not mix depleted and fresh batteries together or serious injury and instrument damage may occur.**

1. Set the multiprobe horizontally on the work surface to prevent water leaking into the multiprobe battery compartment.

2. Unscrew the battery sleeve. Slide the battery sleeve off of the Sonde.
3. Discard the old batteries. Insert the new batteries, **observing polarity markings located on the inside label**. Failure to install the batteries in the correct orientation may cause serious injury and instrument damage.
4. Secure the new batteries with the top and bottom rubber bands (Figure 16).
5. Coat the battery sleeve O-rings sparingly with silicone grease.
6. Screw the battery sleeve back on the Sonde. Do not overtighten or instrument damage will occur.
7. Discard batteries according to local regulations.

**Figure 16 MS5 Battery Replacement**

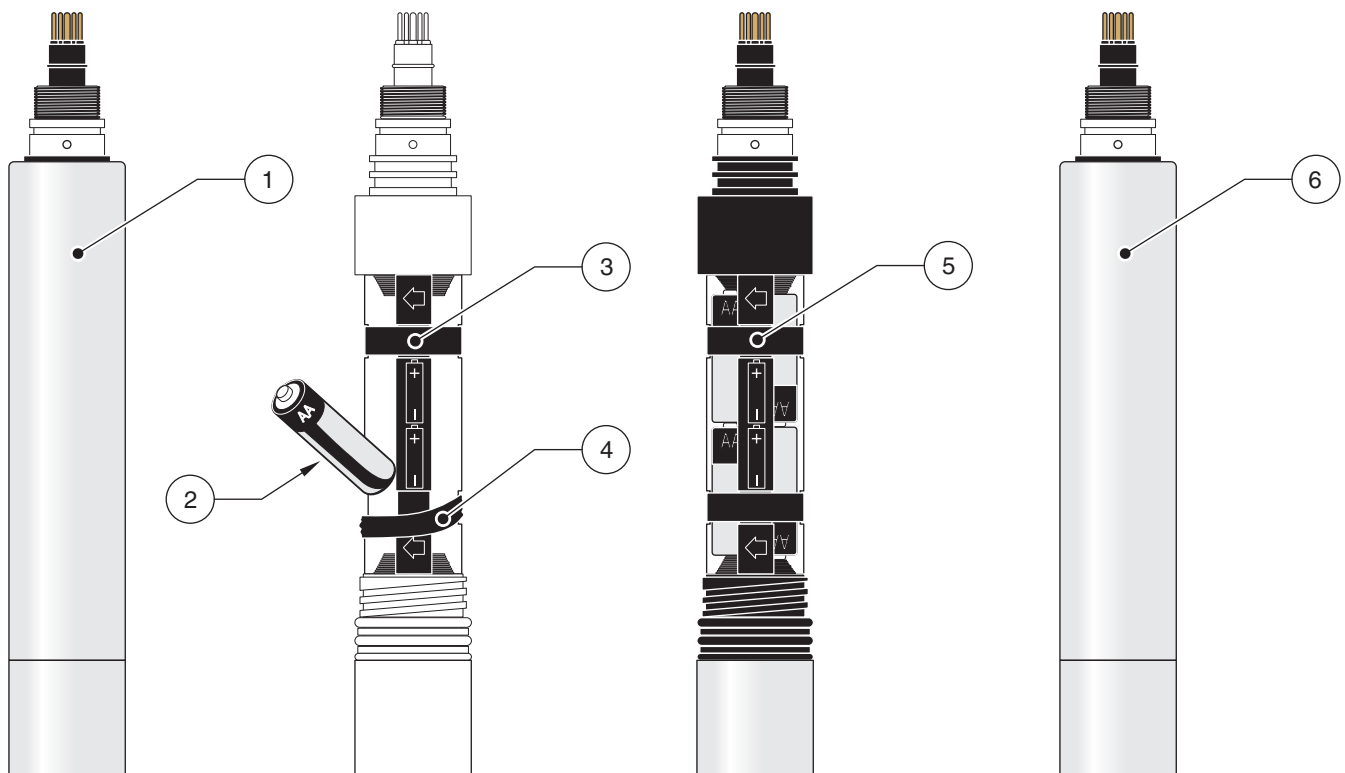

1. Remove the Battery Sleeve	4. Bottom Retaining Rubberband
2. Remove depleted AA Batteries	5. Proper Battery Placement
3. Top Retaining Rubberband	6. Replace the Battery Sleeve

### 6.2.3 Lithium Battery Replacement

The typical replacement period for the lithium battery is once every two years. The lithium battery powers the real-time clock that provides accurate time readings during datalogging. Refer to Figure 17 and Figure 18 and the following instructions for proper lithium battery replacement.

1. Remove the Allen screws with the Allen wrench to remove the multiprobe sensor cap. To help remove the Sonde sensor cap, insert the screwdriver head into the notches on the multiprobe housing at the bottom of the sensor cap.



2. Remove the Sonde body, then slide the sleeve off of the Sonde. Avoid damage to the circuit board.
3. Carefully remove the foil shield.
4. Detach the 10-pin connector ribbon cable.
5. Remove the retaining screw next to the battery clip (Figure 17 and Figure 18).
6. Push the battery out of the battery clip using a small screwdriver.
7. Insert the new battery (Panasonic reference: CR 2032, or equivalent) with the positive sign facing up. Replace and tighten the retaining screw.
8. Reattach the 10-pin connector and replace the foil shield.
9. Apply silicone grease to the sensor cap O-rings.
10. Carefully insert the circuit board and sensor cap assembly.
11. Tighten the Allen screws. **Do not overtighten.**
12. Reset the time and date after replacing the lithium battery. Then enter the time of the location and press **ENTER**.
13. Discard batteries according to local regulations.

**Figure 17** Replacing the Lithium Battery on the DS5 or DS5X

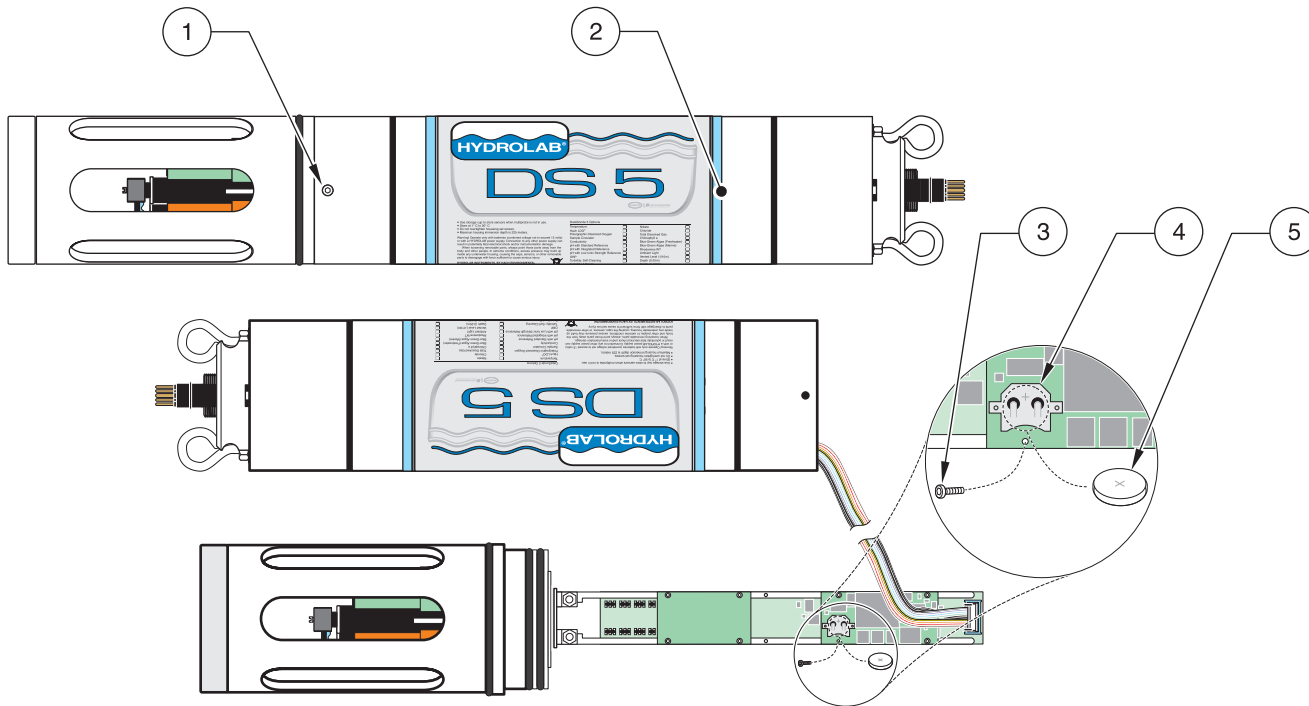

1. Allen Screw	4. Battery Clip
2. Housing	5. Lithium Battery
3. Retaining Screw	

**Figure 18 Replacing the Lithium Battery on the MS5**

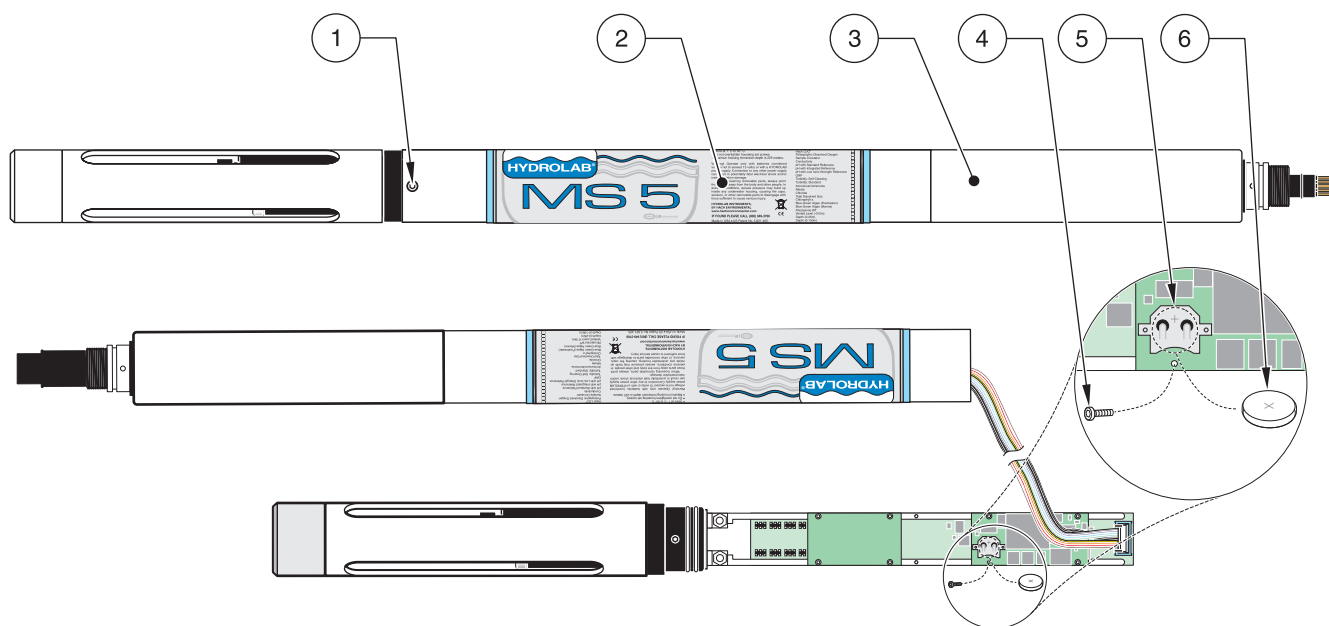

1. Allen Screw	4. Retaining Screw
2. Housing	5. Battery Clip
3. Sonde Body	6. Lithium Battery

## 6.3 Storage and Care Recommendations

### 6.3.1 Multiprobe and Sensor Storage

- Fill the DS storage cup or MS cup with one inch of clean tap water and screw the cup on the multiprobe. To prevent sensors from freezing, store the multiprobe where freezing will not occur.
- Remove batteries for long-term storage. (8 size C alkaline batteries for the DS5 or DS5X or 8 size AA alkaline batteries for the MS5). Do not remove the lithium battery which powers the multiprobe internal clock.
- Store equipment in a carrying case (Cat. No. 011780) or a large plastic container with a circular piece of foam rubber for shock protection.
- Lay the cable in coils of at least 15 cm (6 in.) diameter at the bottom of the plastic container.

### 6.3.2 Electrical Cable Care

- Protect all non-waterproof cables (i.e., all cables except the waterproof underwater cable) from any water source during operation in the field. Keep connectors dry at all times.
- Properly lubricate the sealing surface of all underwater connectors using silicone grease.
- Use protective plugs when the connectors (for underwater and calibration cables) are not connected to any instrument.
- Keep all cables clean, dry, and stored (neatly coiled), in a large plastic container.
- Do not coil cables any tighter than 6 inches in diameter or cable will be damaged.

- Do not knot the cables or use clips to mark a certain depth.
- Do not place the instrument where the cable might be severed or damaged by boat propellers or other moving parts.
- Protect all cables from abrasion, unnecessary tension, repetitive flexure, or bending over sharp radii (e.g., the side of a boat or of a bridge). Do not bend or run the cable over the sheave or pulleys with less than a 6-inch diameter.
- If cables are long, use a battery-powered or hand-cranked reel with electrical slip-rings to lower and raise the instrument. Also, a lighter reel without slip-rings for shorter cables can be used. A last option, is to mount the reel horizontally with the instrument and battery installed in the hub.
- Use the V-shaped support bail to lift and lower the multiprobe.
- Do not apply more than 5 kilograms (10 lb) of sinking weight to the multiprobe. This can increase the possibility of cable breakage due to stress on the attachment points. If more weight is needed, use a wire line to support the instrument by its bail.

## 6.4 Sensor Maintenance

**Important Note:** If a sensor is not in use, insert an optional sensor expansion port plug in the vacant expansion port to prevent any contamination or damage during maintenance, operation, or storage.

## 6.5 Clark Cell Dissolved Oxygen Maintenance

Dissolved oxygen sensor maintenance is required when the membrane covering the cell becomes wrinkled, bubbled, torn, dirty, fouled, or otherwise damaged.

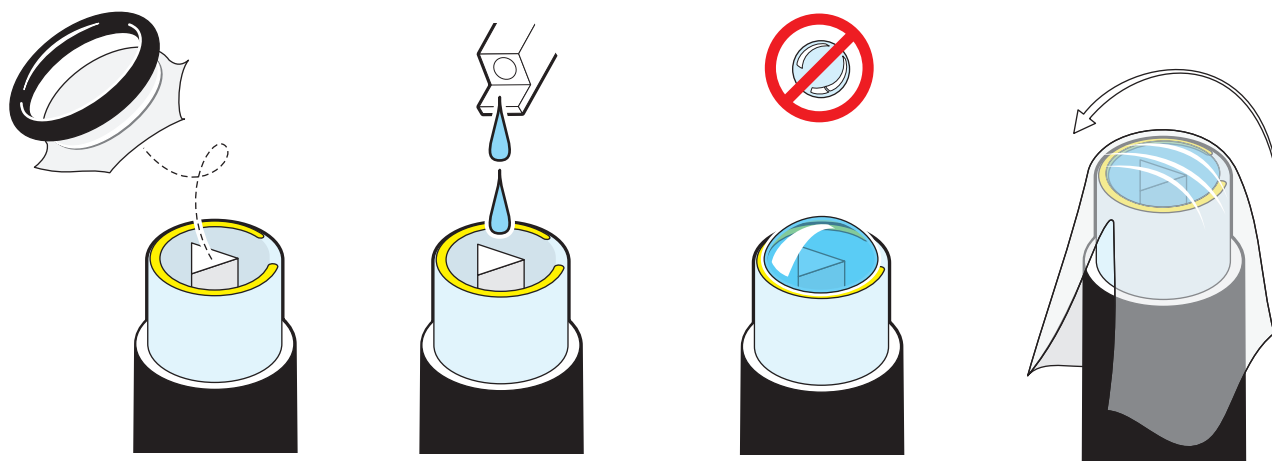

1. Remove the O-ring securing the D.O. membrane. Remove the old membrane. Shake out the old electrolyte and rinse with fresh D.O. electrolyte.
2. Refill with fresh D.O. electrolyte until there is a perceptible meniscus of electrolyte rising above the entire electrode surface of the sensor.
3. Make sure there are no bubbles in the electrolyte.
4. Hold one end of a new membrane against the body of the D.O. sensor with your thumb and with a smooth, firm motion, stretch the other end of the membrane over the sensor surface and hold it in place with your index finger.

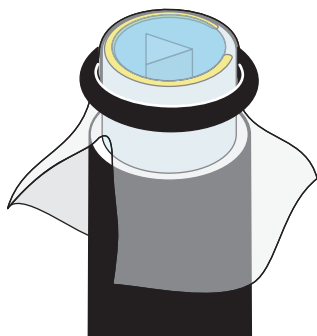

5. Secure the membrane with the O-ring. Make sure there are no wrinkles in the membrane or bubbles in the electrolyte.

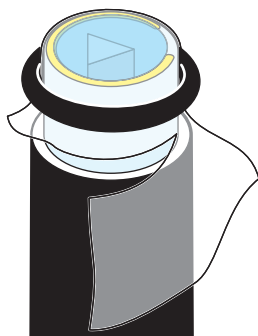

6. Trim away the excess membrane extending below the O-ring.

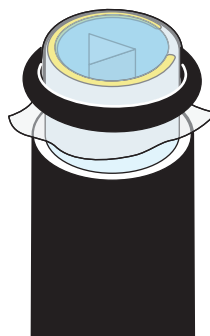

7. Proper membrane assembly.

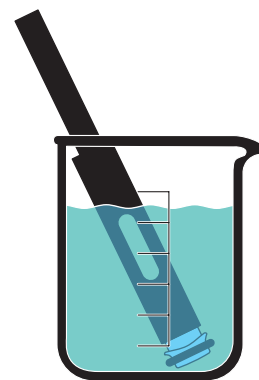

8. Let the sensor soak a minimum of 4 hours (90% relaxed). Ideally, the sensor should soak for 24 hours.

**Note:** Readings may initially drift if calibrated before the membrane is fully relaxed.

## 6.6 Specific Conductance, Salinity, and TDS Maintenance

Clean the oval measurement cell on the specific conductance sensor with a small, non-abrasive brush or cotton swab. Use soap to remove grease, oil, or biological growth. Rinse with water.

## 6.7 ORP Sensor Maintenance

If the platinum band or stud of the ORP sensor gets dirty and/or discolored, polish it with a clean cloth and a very mild abrasive, such as toothpaste; or use a fine polishing strip. Rinse with water. Soak the sensor overnight in tap water to allow the platinum surface to restabilize.

## 6.8 pH Electrode Maintenance

If the pH sensor is coated with oil, sediment, or biological growth, clean the glass with a very clean, soft, wet non-scratching cloth or cotton ball with mild soap. Rinse with tap water. If the pH sensor becomes dehydrated, soak for 24 hours in a pH 4 buffer solution.

## 6.8.1 Standard Reference Electrode

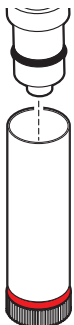

1. Gently pull the entire reference sleeve away from the Transmitter.

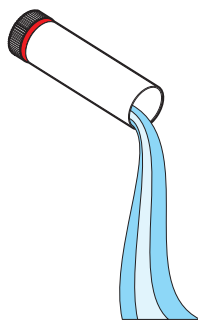

2. Discard the old electrolyte from the reference sleeve.



3. Drop two KCl salt pellets (Cat. No. 005376HY) into the reference sleeve.

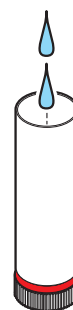

4. Refill the sleeve to the top with reference electrolyte.

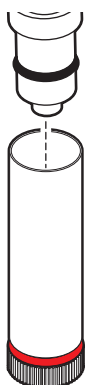

5. With the Transmitter sensors pointed down, push the full reference sleeve back onto its mount until the sleeve has just covered the O-ring located on the mount (just behind the silver electrode).

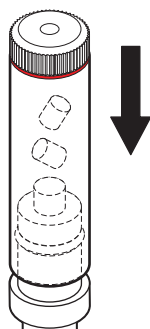

6. Turn the Transmitter so that the sensors point up and push the sleeve the rest of the way onto its mount. Rinse with tap water.

**Note:** The porous Teflon® Reference Junction is the most important part of the pH and ORP performance. Make sure it is clean and passes electrolyte readily. If not, replace it with the spare provided in the maintenance kit. Replacement Reference Junctions are Cat. No. 000548HY.

**Note:** When seating the reference sleeve, trapped air and excess electrolyte are purged. This purging flushes and cleans the porous Teflon® Reference Junction.

### 6.8.2 pH Integrated Sensor

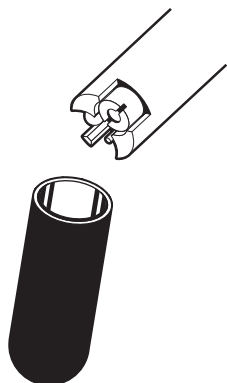

1. Remove the plastic soaking cap. Save the cap for reuse.

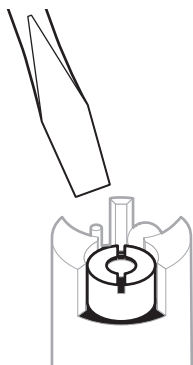

2. Use the supplied screwdriver to loosen the Teflon<sup>®</sup> Reference Junction.

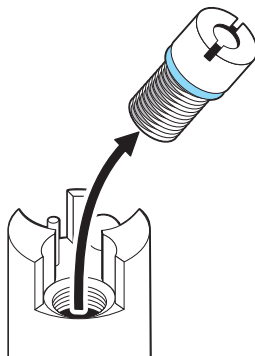

3. Remove the Teflon Reference Junction and discard if dirty or clogged.

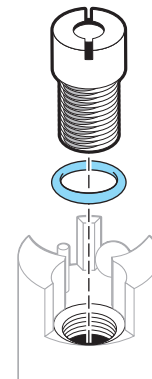

4. Replace the blue O-ring located below the Teflon Reference Junction if it is damaged or loose.

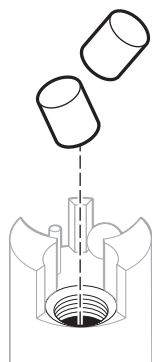

5. Drop two KCl salt pellets (Cat. No. 00537HY) into the reference opening.



6. Inject the pH reference electrolyte into the supplied plastic syringe.

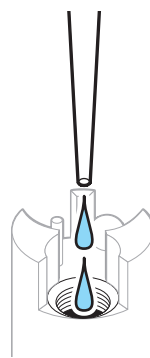

7. Refill the reference opening with electrolyte.

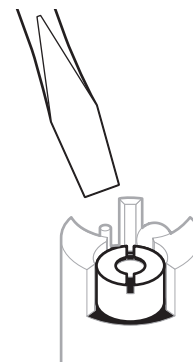

8. Use the supplied screwdriver to install the new Teflon Reference Junction (Cat. No. 002770HY).

### 6.9 Temperature Sensor Maintenance

Use soap or rubbing alcohol to remove grease, oil, or biological growth and rinse with water. Do not use any objects to poke the sensor or the transducer membrane will rupture.

### 6.10 Pressure Sensor Maintenance

1. If calcium deposits are forming in the port, squirt vinegar into the pressure sensor port with a syringe and soak overnight.
2. Soap or rubbing alcohol may be used to remove grease, oil, or biological material. Rinse with water. Do not use any objects to poke the sensor or the transducer membrane will rupture.

### 6.11 Other Sensor Maintenance

Refer to the sensor specific instruction sheet for more information.

## Section 7 Replacement Parts and Accessories

### Replacement Parts

Description	Catalog Number
110 VAC Power Adapter	013450
220 VAC Power Adapter	013460HY
110 VAC External Battery Pack w/Charger	011050
220 VAC External Battery Pack w/Charger	012480
Battery Adapter	011530HY
Battery Plug	004164HY
Cable, 5 meter	015005HY
Cable, 10 meter	015010
Cable, 15 meter	015015HY
Cable, 25 meter	015025
Cable, 30 meter	015030
Cable, 50 meter	015050HY
Cable, 75 meter	015075HY
Cable, 100 meter	015100
Cable, 150 meter	015150
Cable, 200 meter	015200
Cable Reel	013730
Carrying Case	011780
Calibration Cable	013470
Calibration Stand	013910
Hydras 3 LT Software, CD Kit	6234200
Cigarette Lighter Adapter	013210
Conductivity Standard—0.1 mS/cm, 1 L	013610HY
Conductivity Standard—1.413 mS/cm, 1 L	013620HY
Conductivity Standard—12.856 mS/cm, 1 L	013640HY
Conductivity Standard—47.6 mS/cm, 1 L	013650HY
Conductivity Standard—0.5 mS/cm, 1 L	013770HY
DS5, DS5X Bail Kit	013850HY
DS5, DS5X Flow Cell	014120
DS5, DS5X Pipe Kit	013540
DS5, DS5X Basic Maintenance Kit	014680HY
DS5, DS5X Storage Cup (Large)	003608
DS5, DS5X Storage Cup Cap (Large)	003609HY
Clark Cell Dissolved Oxygen Maintenance Kit	013430HY
pH Maintenance Kit	013410HY
DS5, DS5X Weighted Sensor Guard (Large)	014110HY
D.O. Electrolyte, 59 mL	000537HY
D.O. Membrane Pack	002589HY
D.O. Membrane O-ring	000498HY
External Power Adapter Cable	013170HY
Macintosh Adapter Cable	013740
MS5 Bail Kit	013950HY

### Replacement Parts

Description	Catalog Number
MS5 Flow Cell	013520HY
MS5 Flow Cell (for use with turbidity sensor)	014610
MS5 Basic Maintenance Kit	013280
MS5 Weighted Sensor Guard, black (extended)	013760
MS5 Weighted Sensor Guard, black (standard)	013330
MS5 Weighted Sensor Guard, white (extended)	014910
MS5 Weighted Sensor Guard, white (standard)	014920
MS5 Mooring Fixture	013530
MS5 Pipe Kit	013550
MS5 Storage Cup Cap O-ring	002811
MS5 Storage Cup	003306
MS5 Storage Cup (extended)	003395HY
MS5 Weighted Sensor Guard	014130
Modem Adapter	012650
pH Reference Electrolyte, 100 mL	005308HY
Potassium Chloride Pellets (99% KCl), 20 pellets	005376HY
Profiler Data Analysis Software	013350
Retaining Band	005363
SDI-12 and RS485 Adapter Cable	013510
SDI-12 and RS232 Adapter Cable	013790
Small Teflon Junction	002770HY
Thumbscrew for Battery Plug	003301



## Section 8 How to Order

---

### U.S.A. Customers

**By Telephone:**

6:30 a.m. to 5:00 p.m. MST  
Monday through Friday  
(800) 949-3766

**By Fax:**

(970)461-3921

**By Mail:**

Hach Environmental  
P.O. Box 389  
Loveland, Colorado 80539-0389 U.S.A.

**Ordering information by e-mail:** sales@hachenvironmental.com

### Ordering Information Required

- Account number (if available)
- Your name and phone number
- Purchase order number
- Brief description or model number
- Billing address
- Shipping address
- Catalog number
- Quantity

### International Customers

Hach Environmental maintains a worldwide network of dealers and distributors. To locate the representative nearest you, send an e-mail to: sales@hachenvironmental.com or contact:

**Hach Environmental;** Loveland, Colorado, U.S.A.

Telephone: (970) 669-3050; Fax: (970) 669-2932

### Technical and Customer Service (U.S.A. only)

Hach Environmental Technical and Customer Service Department personnel are eager to answer questions about our products and their use.

Call 1 (800) 949-3766 or e-mail techsupport@hachenvironmental.com

## Section 9    **Repair Service**

---

**Authorization must be obtained from Hach Company before sending any items for repair. Please contact the Hach Service Center serving your location.**

**In the United States and Outside Europe:**

Hach Company  
Hach Environmental Product Repair  
North Dock  
5600 Lindbergh Drive  
Loveland, CO 80539-0389  
Telephone: (800) 227-4224 ext 2080  
Fax: (970) 461-3924

**In Europe:**

OTT Hydromet GmbH  
Ludwigstrasse 16  
87437 Kempten  
Germany  
Telephone: +49/831/5617-0  
Fax: +49/831/5617-209

## Section 10 Limited Warranty

---

Hach Company warrants the Hydrolab Series 5 Sondes to the original purchaser against any defects that are due to faulty material or workmanship for a period of two years from date of shipment unless otherwise noted.

In the event that a defect is discovered during the warranty period, Hach Company agrees that, at its option, it will repair or replace the defective product or refund the purchase price excluding original shipping and handling charges. Any product repaired or replaced under this warranty will be warranted only for the remainder of the original product warranty period.

This warranty does not apply to consumable products such as chemical reagents; or consumable components of a product, such as, but not limited to, lamps and tubing.

Contact Hach Company or your distributor to initiate warranty support. Products may not be returned without authorization from Hach Company.

### Limitations

This warranty does not cover:

- Damage caused by acts of God, natural disaster, labor unrest, acts of war (declared or undeclared), terrorism, civil strife or acts of any governmental jurisdiction
- Damage caused by misuse, neglect, accident or improper application or installation
- Damage caused by any repair or attempted repair not authorized by Hach Company
- Any product not used in accordance with the instructions furnished by Hach Company
- Freight charges to return merchandise to Hach Company
- Freight charges on expedited or express shipment of warranted parts or product
- Travel fees associated with on-site warranty repair

This warranty contains the sole express warranty made by Hach Company in connection with its products. All implied warranties, including without limitation, the warranties of merchantability and fitness for a particular purpose, are expressly disclaimed.

Some states within the United States do not allow the disclaimer of implied warranties and if this is true in your state the above limitation may not apply to you. This warranty gives you specific rights, and you may also have other rights that vary from state to state.

This warranty constitutes the final, complete, and exclusive statement of warranty terms and no person is authorized to make any other warranties or representations on behalf of Hach Company.

### Limitation of Remedies

The remedies of repair, replacement or refund of purchase price as stated above are the exclusive remedies for the breach of this warranty. On the basis of strict liability or under any other legal theory, in no event shall Hach Company be liable for any incidental or consequential damages of any kind for breach of warranty or negligence.



## Troubleshooting Communications

If the first screen does not appear, after booting up the communications software and connecting the multiprobe to the computer, please check the following items:

### Troubleshooting Hydras 3LT

If Hydras 3LT does not automatically detect the Sonde when launched:

Press the **RE-SCAN FOR SONDES** button.

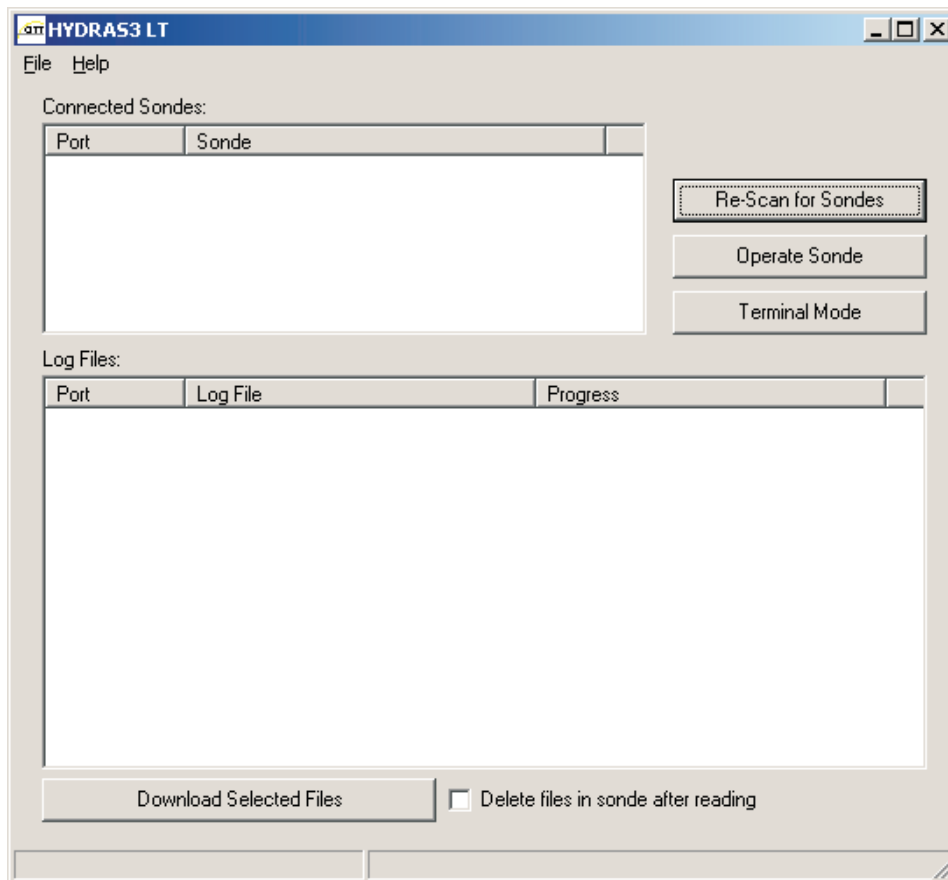

If communication is still not established after several attempts, try the following:

1. Verify that the instrument is powered on and functioning.
2. Check power cables and connections. Verify that your PC and multiprobe are properly connected to the wall outlet or external battery if used.
3. Verify that the input voltage to the multiprobe is between 7V and 18V.
4. If your multiprobe is equipped with an internal battery pack, check the batteries' polarity and voltages.

Verify the Hydras 3 LT Communication Settings.

1. Select File>Options from the Hydras 3 LT Connection Screen.

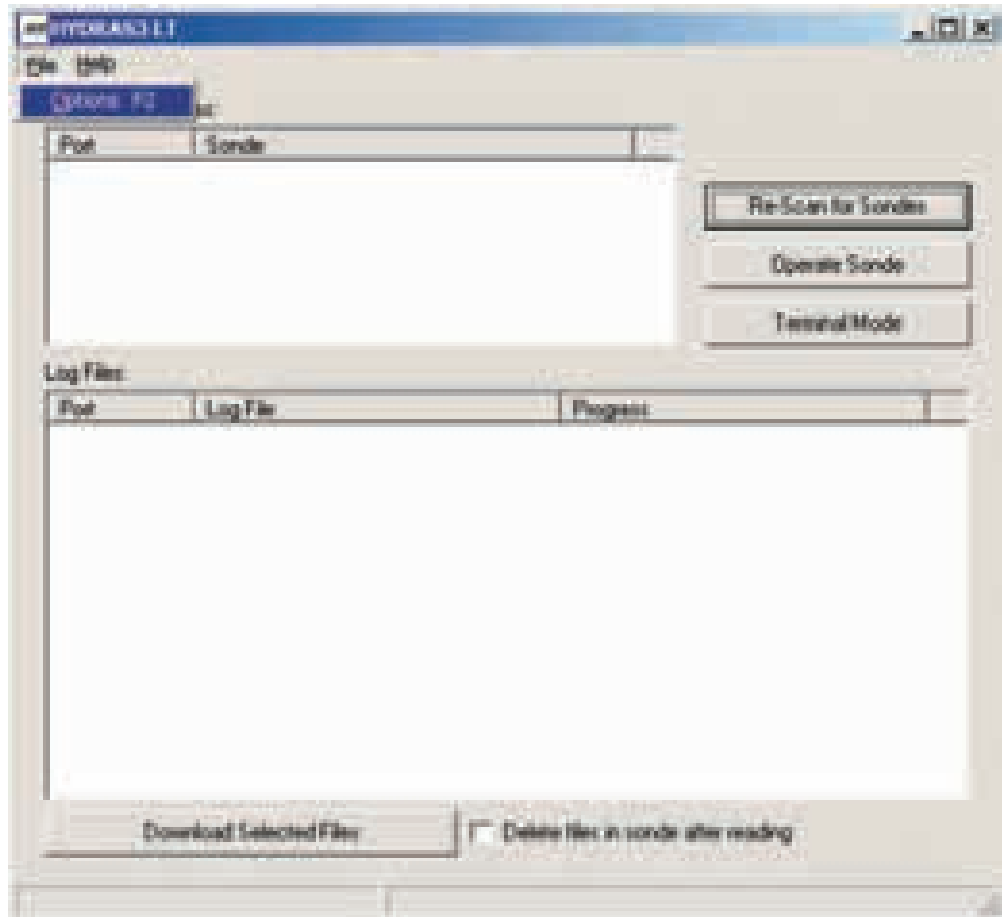

2. If the Sondes/PC baud rate and COM port are known, disable the COM Port and baud rate auto scans and set Hydras3LT to use the known values.

- In addition, the connection timeout may be extended from 10 to 15 seconds, which will allow time for additional retries.

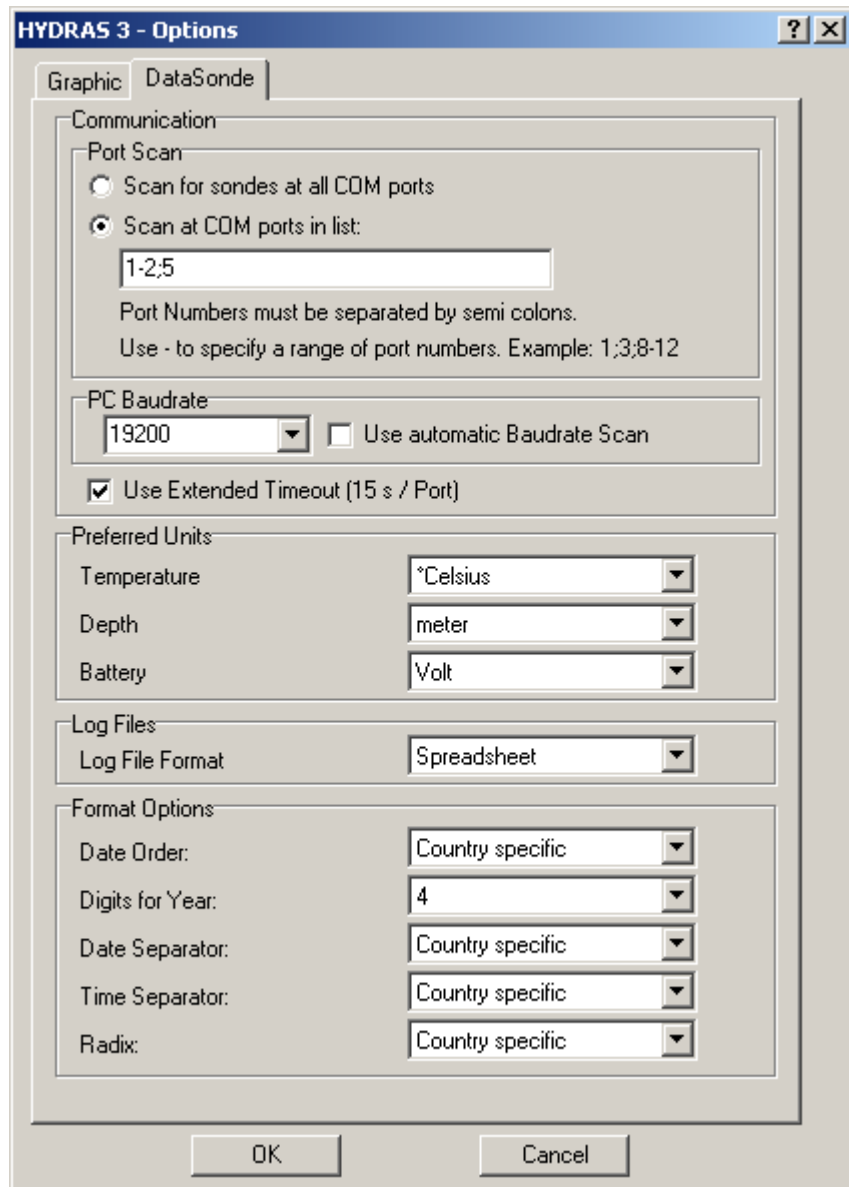

### Troubleshooting using Terminal Mode

Check the PC and terminal emulation or communication software:

- Start the communications software before connecting the instrument.
- Verify that the PC is on and that communication software is running.
- Verify that the correct communication port was selected (COM 1, 2, 3, 4).
- Verify that the terminal was set to ANSI terminal emulation, and that the correct baud rate (19200), eight bits, no parity, and one stop bit (19200, 8, N, 1) was selected.
- If using a 100 meter or longer cable with the Surveyor, make sure the terminal baud rate is set to 9600 and the Sonde baud rate is 9600.

### Check the power cables and connections:

- Verify that the PC and multiprobe are properly connected to the wall power outlet or external battery is used.
- Verify that the input voltage to the multiprobe is between 10 and 15 volts.
- Verify that the battery pack is installed correctly, if applicable. Check the battery polarity and voltages.

### Check the internal components:

- Make sure all internal connections are securely seated.
- Check for the presence of water in the unit. If damp or wet, dry out thoroughly with a lint-free cloth or towel or let it sit out opened in a dry room overnight. Determine where the leak occurred and repair appropriately. Notify Technical Support for help on preventing further leaks.

**If these checks do not reveal the problem, try to substitute other instruments, cables, and terminals to determine the failing component.**

## Troubleshooting Sensor Issues

The following list is not an extensive account of the problems encountered. If the following solutions do not reveal the problem, try to substitute other sensors to determine the failing component.

**Table 1 Sensor Troubleshooting**

Problem	Solution
D.O. readings are too low to calibrate and/or pH and/or Redox are very high or very low	Check the value of the sample solution
	Ensure the sensors are properly maintained.
D.O. readings seem wrong	Ensure the D.O. sensor has been properly maintained and calibrated.
Conductivity, Temperature, and/or Depth readings seem wrong	Ensure the sensors are properly maintained and calibrated.
	Ensure the readings displayed are accurate (e.g., for Depth: meters, feet, or psi).

**Table 2 Multiprobe Software Symbols**

Symbol	Description
#	Data Out of Sensor Range
?	User Service Required or Data Outside Calibrated Range but Still within Sensor Range
*	Parameter is Not Calibrated
~	Temperature Compensation Error
@	Non Temperature Parameter Compensation Error



# Appendix B External Communications

## B.1 SDI-12 Interface

SDI-12 is an industry-originated, serial digital interface bus designed to allow an operator to connect a wide variety of sensors (meteorological, hydrological, water quality, etc.) to a single SDI-12 datalogger with a single cable bus.

The multiprobe is compatible with SDI-12 V1.2. A copy of the specification can be found at [www.sdi-12.org](http://www.sdi-12.org). The optional SDI-12 Interface Adapter Cable is required to operate the multiprobe with an SDI-12 Datalogger.

**Note:** All three wires (one ground) must be connected for correct SDI-12 operation.

A label on the SDI-12 Interface Adapter Cable shows the pinout in [Figure 19](#).

1. Connect the data cable to the SDI-12 Interface Adapter Cable connector.
2. Disconnect power from the multiprobe.
3. Connect the bare wires at the end of the SDI-12 Interface Adapter Cable to the appropriate connections on the SDI-12 datalogger. Follow the label on the SDI-12 Interface Adapter.

**Figure 19** SDI-12 Cable

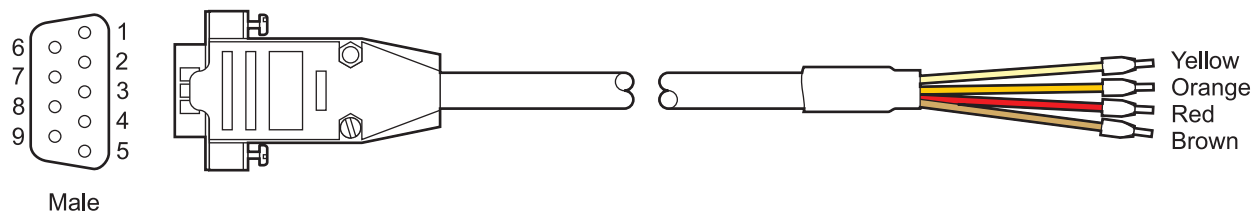

**Table 3 SDI-12 Pinouts**

Pin Number	Wire Color <sup>1</sup>	SDI-12 Function
4	Brown	+12 VDC
5	Red	Ground
8	Orange	SDI-12 Data
9	Yellow	SDI-12 Return

<sup>1</sup> Wire color is valid only for this cable (Cat. No 007139). Use of other cables or cable modifications may result in instrument damage.

Consult the SDI-12 datalogger manual for information on how to connect the SDI-12 Interface Adapter.

**Note:** SDI-12 parameters can be setup through Hydras 3 LT.

Table 4 is a summary of the SDI-12 user commands supported by the multiprobe. For more details on correct use, consult the SDI-12 V1.2 specification.

**Table 4 SDI-12 Commands**

Command <sup>1</sup>	Response	Description
a!	a<crLf>	Address Acknowledge
a!	aXXHydrolabYYYYYYZZZZserialnumber<crLf>	Identify XX: SDI-12 Support Version YYYYYY: Instrument ID ZZZZ: Software Version
aAb!	b<crLf>	Change address from a to b
aM!	addn<crLf>	Measure n values in ddd seconds
aDx!	aSvalueSvalue...<crLf>	Report Data
aRx!	aSvalueSvalue...<crLf>	Report Continuous Data
aC!	addnn<crLf>	Concurrent Measure: nn values in ddd seconds
aXC!	aXC<crLf>	Initiate a cleaning cycle in units equipped with a wiper
aX1!	aX1<crLf>	Enable Continuous Mode
aX0!	aX0<crLf>	Disable Continuous Mode
aXSS1!	aXSS1<crLf>	Circulator On
aXSS0!	aXSS0<crLf>	Circulator Off

<sup>1</sup> The 'a' used in the SDI-12 commands is the SDI-12 address. The Transmitter's factory default SDI-12 address is '0'.

## B.2 Connection to an External Device

The Series 5 Multiprobe can communicate with an external device using an RS232, RS485, or SDI-12 interface. The RS232 interface is always available. The Series 5 Multiprobe must be programmed for communication via an RS485 or SDI-12 interface.

Two cables are available for external communication: a 6-pin marine to DB-9 cable (Cat. No. 015xxx), and a DB-9 to external device cable (Cat. No. 013510) for SDI-12 or RS485 interfaces (Figure 20). Wiring diagrams for these cables are shown in Figure 22 and Figure 23. Wiring for the 6-pin Sonde connector is shown in Figure 21. Wiring to the external device is detailed in Table 5.

**Figure 20 Communication Cables for the DS5, DS5X, and MS5 Water Quality Sondes**

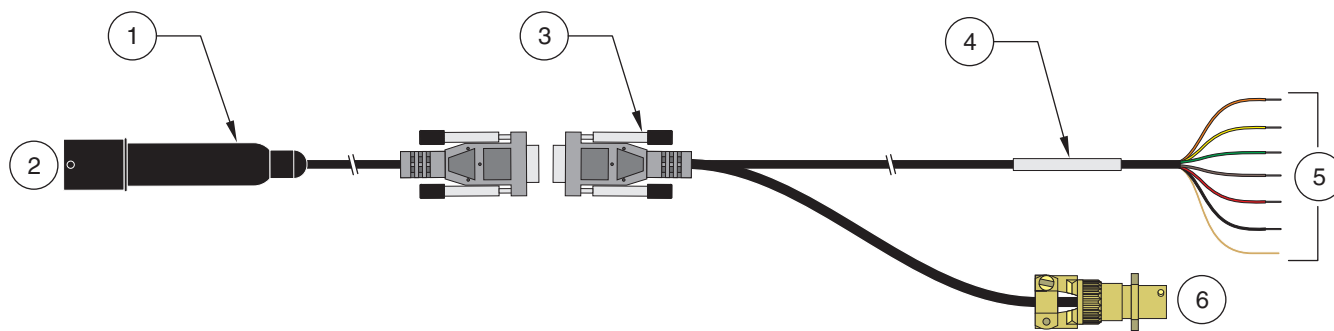

1. Cable, 6-pin marine to DB-9 (Cat. No. 015XXX)	4. Label, wire connections
2. Connection to DS5, DS5X or MS5	5. Connections to external device
3. Cable for SDI-12/RS485 (Cat. No. 013510)	6. Connection to power

**Figure 21** Wiring for 6-Pin Marine Connector on Multiprobe

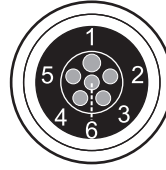

Male

1. External Power	3. RS232 TXD	5. RS485 + or SDI-12 DATA
2. Ground	4. RS232 RXD	6. RS485 - or SDI-12 RETURN

**Figure 22** Wiring Diagram for Cable 015xxx, 6-Pin Marine to DB-9

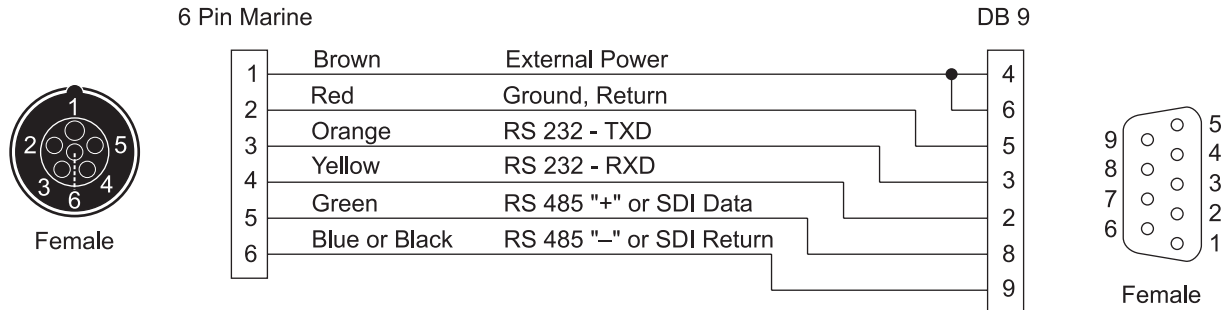

**Figure 23** Wiring Diagram for Cable 013510, DB-9 to External Data Device

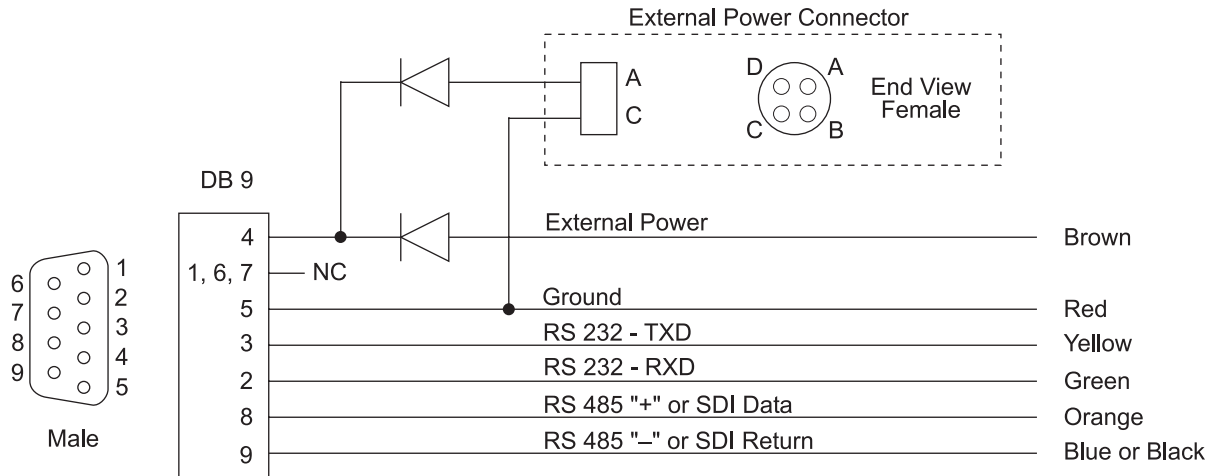

**Table 5** Wiring Connections for External Device (Cable 013510)

Wire Color	RS232	RS485	SDI-12
Brown	+12VCD IN	+12VDC IN	+12VCD IN
Red/Shield	Ground	Ground	Ground
Green	RS232 RX	—	—
Yellow	RS232 TX	—	—
Orange	—	RS485 +	SDI DATA
Blue or Black	—	RS485 -	SDI RETURN

### B.3 RS485 Interface

Series 5 Multiprobes are compatible with RS485 interfaces. RS485 is a standard that specifies a particular method to transmit and receive digital signals. This standard is maintained by the Electronic Industries Association in a document titled "Standard for Electrical Characteristics of Generators and Receivers for Use in Balanced Digital Multipoint Systems."

RS485 involves sending an inverted or out-of-phase copy of the signal simultaneously on a second wire. This is called a balanced transmission. Any outside electrical noise adds coherently to both signal copies. The receiver electrically subtracts the two signals to reproduce the original signal. The advantage in the subtraction is that only the intended signal gets reproduced since they are out-of-phase. The in-phase noise on the two wires are also subtracted from each other to produce a net zero noise component in the reproduced signal. This noise immunity allows the RS485 interface to transmit digital signals at faster rates over longer distances than the RS232/SDI-12 interface. The RS232/SDI-12 interface does not use balanced transmission and is therefore susceptible to noise interference which limits the transmission distance and speed.

#### Connections

RS485 can use two wires to both transmit and receive data. A common software protocol must be shared between devices to prevent data collisions on the wires. RS485 also allows for multiple transmitters and receivers to be easily connected together.

Be sure to connect the signal grounds of all devices on the network together. The connection can be made using a conductor in the transmission cable or each device can be connected to a good earth ground. This connection keeps the common mode voltage (the voltage which the signal must overcome to be reproduced) low. The network devices may operate without the signal ground connection, but may not be reliable.

Some RS485 applications require impedance termination because of fast data rates or long cables. The most popular termination involves installing a ½ watt resistor across the receiver at each end of the network. See the RS485 interface user manual for termination requirements on the PC being used.

Alternatively, the preferred network may be AC terminated by placing a 0.01 µF capacitor in series with the terminating resistor. The capacitor appears as a short circuit during signal transitions but appears as an open circuit to any DC loop current. This will reduce the power supply current required to operate the network and still provide the proper terminating impedance.

Do not add a terminating resistor to every receiver in the network. For networks with more than about four nodes, the transmitters will be unable to drive the cable. Only terminate both ends of the main cable.

### B.4 Modbus Interface

The multiprobe is configured to respond to Modbus function 3 (Read Holding Registers) in RTU mode through the RS232 or RS485 communications port at 19200 baud, 8 data bits, Even Parity, and 1 stop bit (19200:8:E:1).

All data values are returned in IEEE Floating Point Format (4 bytes). Each data value is returned in two 16 bit words with the low word being transmitted first. Within each word, the high byte is transmitted first. Each byte is transmitted Most Significant Bit first. For example, the floating point value 1.56 = 0x3FC7AE14 would be transmitted as 0xAE 0x14 0x3F 0xC7.

All available data parameters are stored in Holding Registers within the multiprobe, which start counting at 40001. They are addressed in the Modbus message structure with addresses starting at 0. Modbus function 03 is used to request one or more holding register values from the multiprobe. Each Holding Register is 16 bits (2 bytes) in size, therefore two Holding Registers (4 bytes) are required to represent a single floating point value. Only one slave device can be addressed in a single query. The query structure is detailed in [Table 6](#). A complete register list can be found at [www.hachenvironmental.com](http://www.hachenvironmental.com).

**Table 6 Function 03 Query Structure**

Byte	Value	Description
1	1–247	Slave device address
2	3	Function code
3	0–255	Starting address, high byte
4	0–255	Starting address, low byte
5	0–255	Number of registers, high byte
6	0–255	Number of registers, low byte
7	0–255	CRC, high byte
8	0–255	CRC, low byte

After processing the query, the multiprobe will return the 16 bit Holding Register values that were requested. The Holding registers will be transmitted as High Byte first, followed by the Low Byte. The Modbus response starts with the multiprobe address and the function code 03. The next byte is the number of data bytes that follow. This value is two times the number of registers returned. The two byte CRC is appended at the end.

**Example:** The multiprobe stores pH information at holding registers 40007 and 40008. These registers are addressed as 0x0006 and 0x0007. The following sequence of bytes request pH from a multiprobe with slave address 1.

**pH Query Example:**

Byte 1 <sup>1</sup>	Byte 2 <sup>2</sup>	Byte 3 <sup>3</sup>	Byte 4 <sup>3</sup>	Byte 5 <sup>4</sup>	Byte 6 <sup>4</sup>	Byte 7 <sup>5</sup>	Byte 8 <sup>5</sup>
0x01	0x03	0x00	0x06	0x00	0x02	0x24	0x0A

- <sup>1</sup> Slave Address
- <sup>2</sup> Command 3—Read Holding Register
- <sup>3</sup> Address of the first Holding Register to read (0x0006)
- <sup>4</sup> Number of Holding Registers to Read (2 registers—4 bytes)
- <sup>5</sup> CRC

**Response:**

Byte 1 <sup>1</sup>	Byte 2 <sup>2</sup>	Byte 3 <sup>3</sup>	Byte 4 <sup>4</sup>	Byte 5 <sup>4</sup>	Byte 6 <sup>4</sup>	Byte 7 <sup>4</sup>	Byte 8 <sup>5</sup>	Byte 9 <sup>5</sup>
0x01	0x03	0x04	0xA8	0xC9	0x41	0x06	0xBA	0x3F

- <sup>1</sup> Slave Address
- <sup>2</sup> Command 3—Read Holding Register
- <sup>3</sup> Number of Data Bytes (4 bytes—2 registers)
- <sup>4</sup> pH
- <sup>5</sup> CRC

**Result:** The data is sent Low Word First, High Byte First, therefore the IEEE Floating Point Formatted value representing the pH is: 0x4106A8C9 = 8.416 Units.

## B.5 Using a Modem with Multiprobes

### Field Modem

All multiprobes require a modem adapter to enable communications with a commercial telephone modem. The modem adapter provides the necessary handshaking and connections to allow a modem to properly answer the incoming call and power down the multiprobe when the call is terminated. The Modem Adapter has a connector (labeled modem) that connects to the RS232 connection of the modem. The other connector (labeled multiprobe) on the Modem Adapter connects to the multiprobe using a Interface cable and Underwater cable, or a Calibration cable. A 25 to 9 pin adapter is also required for the cables.

The Modem Adapter does not require a power supply, however, the multiprobe and the modem will require power. Usually, commercial modems are supplied with a wall-cube power supply that converts ac mains voltage to 9–12 volts DC. Most modem can use the multiprobe power supply by making a cable with the corrector connector for the modem power input.

The modem, Modem Adapter, power supply, and associate cabling are not water-proof, and should be installed in a water-tight enclosure. If AC power is used, then a GFI (ground fault interrupt) device should be installed in the ac wiring to prevent electrocution. Program the modem as follows:

**Table 7 Field Modem Commands<sup>1</sup>**

Command	Function
AT&C1	Enable carrier detection
AT&D3	Enable DTR detection
AT&K4	Enable XON/XOFF handshaking
AT&Q0	No error correction or buffering
AT&S0	Force continuous DSR
AT%C0	Disable data compression
ATS0=1	Answer on first ring
AT&W0	Save current settings

<sup>1</sup> The modem will automatically use this setup every time it is powered on.

### Office Modem Installation

The office modem is connected to the computer serial port using a standard RS232 connection. Program the modem as follows:

**Table 8 Office Modem Commands<sup>1</sup>**

Command	Function
ATW1	Report connection speed & protocol
AT&C1	Enable carrier detection
AT&K4	Enable XON/XOFF handshaking
AT&Q0	No error correction or buffering
AT%C0	Disable data compression
AT&W0	Save current settings

<sup>1</sup> The modem will automatically use this setup every time it is powered on.

The computer will need a terminal emulation program to communicate with the remote multiprobe. Setup the program to provide ANSI terminal emulation, 19200 baud, no parity, 8 data bits, and 1 stop bit for Series 5 Multiprobes. Setup the software to provide a direct connection to the COM port connected to the modem.

### **Operating the Modem**

Check if the modem is communicating with PC by typing AT and pressing **ENTER**. The modem should respond with OK. To access a remote site from the office, type ATD followed by the phone number, for example, ATD15122558841. Add the proper prefixes to the phone number such as 9 (for PBX office systems) or 1 (for long distance). Press **ENTER**. The modem should start dialing the number and negotiating the connection. Series 5 Multiprobes may require as long as 15 seconds to show the startup screen. If the startup screen is not displayed, send a Break by typing **ALT-B**. Telephone noise and delay may prevent the Series 5 Multiprobe from properly determining the presence of an ANSI terminal. You will not be able to access a Series 5 Multiprobe if logging event is currently active. This can be avoided by setting the interval to no less than 2 minutes to allow enough time to call the modem between logging events (a logging event occurring during a call will not cause a problem).

### B.6 TTY Mode

The sonde is equipped with a TTY Communication Mode, which enables the Sonde to send an ASCII string of characters, representing selected parameter values, once per second. Parameters and Parameter Order may be selected using the "Define SDI Parameter Order" button in the SDI section of the Settings Tab.

To enter TTY Mode:

1. Press **ENTER** in the TTY Mode section of the Settings Tab.
2. Press **YES** to verify the entry in mode.

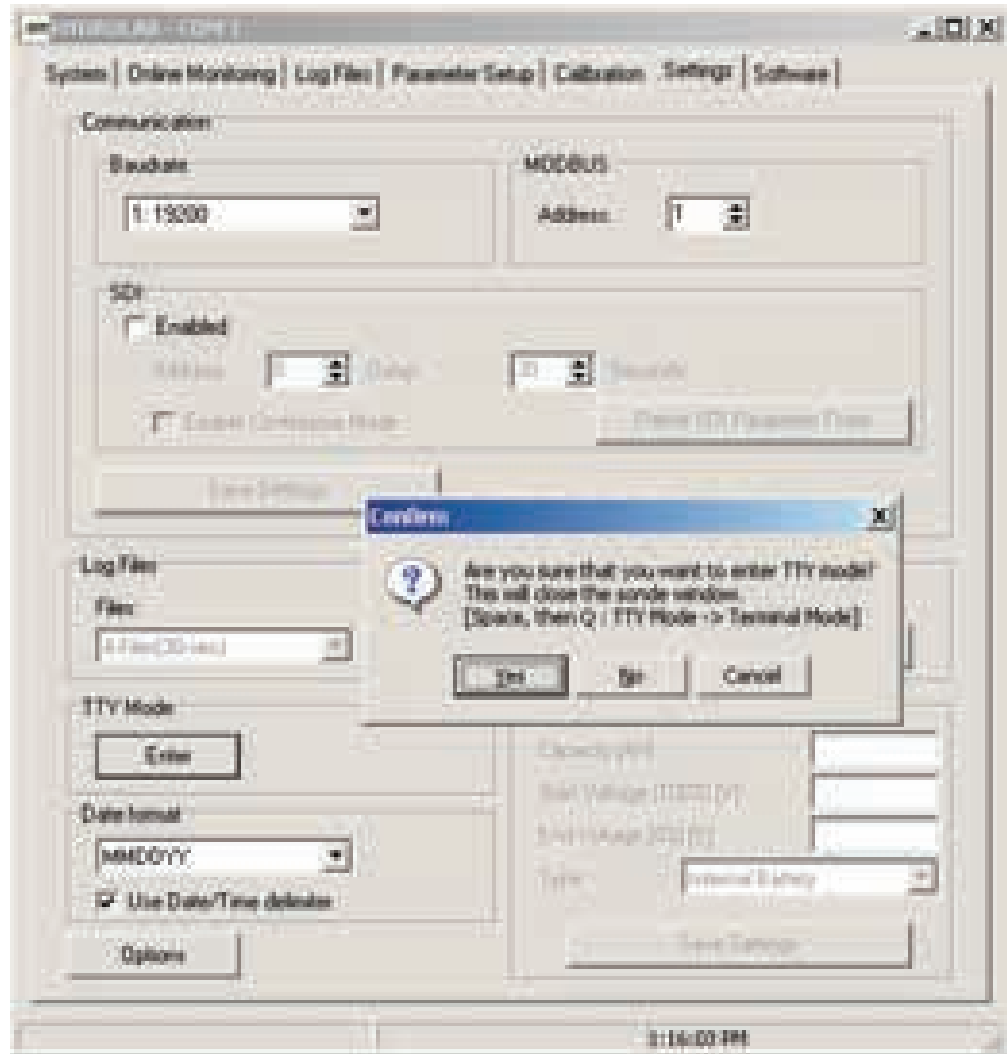

Once the Sonde has been placed in TTY mode, it will no longer communicate with Hydras3LT except in terminal mode. The Sonde will retain its current baud rate. Any ANSI terminal emulator may be used to communicate with the Sonde at 8 data bits, No Parity, and 1 stop bit.



## B.6.1 TTY Menu and Commands

The TTY menu is accessed by first pressing the spacebar (or sending an ASCII space character). The multiprobe will finish any line in progress and then start a new line (by sending <cr><lf>) followed by the menu:

```
<cr><lf>HM?:<sp>
```

The multiprobe will echo the user entry if it is listed in the menu, otherwise an ASCII BEL character is sent. An ASCII escape character will abort the menu after displaying a cancel message.

Responding with a ? will produce a verbose version of the menu:

```
<cr><lf>Main Menu<cr><lf>
(H)eader<cr><lf>
(M)easure<cr><lf>
(Q)uit TTY Mode<cr><lf>
Please enter your choice:<sp>
```

### A. (H)header

Responding with an **H** will show a header identifying the data fields with name and units. In addition, the instrument ID is displayed:

```
HM?:<sp>H<cr><lf>
<cr><lf>Instrument Id<cr><lf>
<cr><lf><sp><sp>Time<sp><sp><sp>Temp<sp><sp>lbatt<cr><lf>
HHMMSS<sp><sp><sp><sp><sp>°C<sp><sp>Volts<cr><lf>
```

The first line is free-field text up to 20 characters in length. The next line is skipped and the data names are printed. The names are right-justified (with leading spaces inserted) to produce a constant width field. Most fields are 6 characters wide, however fields can also be 5, 7, or 8 characters wide. The name fields are always separated with a space. Any name may appear in any field depending on how the user configured the data display in ANSI mode.

The next line shows the corresponding units for the data fields. The units are right-justified text (with leading spaces inserted) to produce a constant-width field equal to the name field. The name fields are always separated with a space.

### B. (M)measure

Responding with an **M** will force the multiprobe to send one line of data without waiting for the next data display interval. This is useful for synchronizing data acquisition software with the multiprobe data output. The data values are right-justified to fill a constant-width field of 5, 6, 7, or 8 characters.

```
HM?:<sp>M<cr><lf>
231302<sp><sp>24.59<sp><sp><sp>12.0<cr><lf>
```

Data values may also be appended with a special character (\*, ~, @, #, or ?). Data values without an appended character will always have a space separator, however, the appended character may be the only separator between values; a space separator is not guaranteed.

Data values that are too large to fit in the constant-width field, are modified so that the numeric digits are displayed as # (##.## for example). The sign and decimal point are preserved.

### C. (Q)uit

Responding with a **Q** or **q** will reset the multiprobe to full terminal mode and can then be connected to Hydras 3 LT.

## B.6.2 Data Display

If the TTY menu is not used, a line of data is periodically displayed on the next available line. If the screen is full, the lines are scrolled. All data lines are terminated with <cr><lf> and have the same formatting as the (M)easeure command described above.

# Appendix C Using HyperTerminal

---

## C.1 HyperTerminal Setup

1. After starting Windows, click on the Start button.
2. Select Programs>Accessories>Communications>Hyperterminal.
3. Enter a name and choose an icon for the application and click **OK**.
4. Select the COM port and click **OK**. Set the communication in a 19200/8/N/Xon-Xoff format.
5. Configure HyperTerminal so the functions, arrows, and **Ctrl** keys act as terminal keys, not window keys. Select the ANSI terminal emulation. File>Properties>Settings.
6. Use [Table 9](#) to communicate with or recover information from the multiprobe.

**Table 9 HyperTerminal Commands**

<b>Follow the Path:</b>	<b>To:</b>
Help: Help Topics: Index: HyperTerminal	Displays the on-line help utility.
File: Properties: Phone number: Configure: Maximum speed	Access and select the modem transfer speed (e.g. 19200 bps)
File: Properties: Phone number: Configure: Connection	Access and select the connection settings (e.g. N, 8, 1)
Transfer: Capture Text	Enable a capture file, to log the data currently received to a disk or to a hard drive. You will be prompted for a file name and a path.
File: Capture to printer	Turn the printer on.
Transfer: Send file	Upload a file and choose the transfer protocol (e.g. Xmodem). You will be prompted for a file name and a path.
Transfer: Receive File	Download a file and choose the transfer protocol (e.g. Xmodem). You will be prompted for a file name and a path.
File: Open	To view a file or find a saved file in the HyperTerminal folder.



## Appendix D Glossary & Abbreviations

---

**Ammonia (NH<sub>3</sub>)**—A colorless gaseous alkaline compound which is soluble in water. It has a characteristic pungent odor, and is used as a fertilizer. In water and soil, ammonia is present primarily as NH<sub>4</sub><sup>+</sup> ions and is readily assimilated by plants during nutrition.

**Ammonium (NH<sub>4</sub><sup>+</sup>)**—Ammonium is a form of ammonia by the addition of a hydrogen ion (H<sup>+</sup>) to an ammonia molecule (NH<sub>3</sub>). Ammonia is converted to ammonium as the pH of a solution drops. Ammonium is less harmful to aquatic life than ammonia. Below a pH of 7.3, more than 99% of the total ammonia is present as ammonium.

**Assembly**—A unit containing the component parts of a mechanism, machine, or similar device. Probe Assembly: The unit containing the component parts of a sensor (e.g. D.O.:component consisting of the D.O. sensor which is made up of 2 electrodes the cathode and the anode).

**Chloride (Cl<sup>-</sup>)**—A common anion, present in both fresh and sea water. It is essentially non-toxic, and is present in all living cells.

**Conductivity**—Conductivity is inversely related to the resistance of a solution. Conductivity is the ratio of the electric current density to the electric field in a material, also known as electrical conductivity. In limnology, conductivity is a measure of the ability of water to pass an electrical current. Compensation of this measurement to 25 °C constitutes specific conductance. This parameter indicates the amount of dissolved substances (salts). Salts and their concentration dictate osmoregulatory (salt-balancing) functions in plants and animals. The ionic strength of water also regulates the toxicity of many substances. (See: Specific conductance)

**Data collection platform (or DCP)**—Hardware system and system software used with a computer program to collect data at one or more locations.

**Depth**—The vertical distance between the water surface and another level (for a multiprobe: 0–10, 0–25, 0–100, or 0–200 meters). (See: Vented depth)

**Derating**—The reduction of the rating of a device to improve reliability or to predict operation at higher or lower ambient temperatures.

**Dissolved oxygen (or D.O.)**—A measure of the amount of oxygen present in water and available for respiration. The concentration of D.O. is controlled by many factors including: consumption by aerobic (requiring D.O.) organisms (bacteria, fish, amphibians, and invertebrates); consumption by plants (algae, vascular plants, particularly during dark hours); and water temperature, water flow, and depth

**Drift**— The long-term lack of repeatability caused by fouling of the sensor, shifts in the calibration of the system, or slowly failing sensors.

**Dump**—To copy the contents of all or part of a storage, usually from an internal storage device to an external storage device.

**Eh**—(See: Redox potential)

**Electrode**—An electric conductor which either measures the potential of a solution (pH, reference, redox, and ammonium electrodes) or forces electric current into or out of a solution (D.O. and conductivity electrodes).

**Emery cloth**—An abrasive cloth or paper with an adherent layer of emery powder; used to polish and clean metal. (No. 400 or finer is recommended.)

**Hysteresis error**—The maximum separation due to hysteresis between upscale-and downscale-going indications of a measured value. A difference in parameter readings which occurs due to a variation in the conditions under which the sensor approached the readings. (See: Response time)

**Isopotential point**—The point at which the ion activity is the same on both sides of a sensor membrane. At the isopotential points, there is a zero potential across the membrane. The observed potential of the sensor may not be zero, due to the differences in reference electrodes.

**Milliohm ( $m\Omega$ )**—Unit of resistance (not conductivity or conductance.)

**MilliSiemens ( $mS$ ) = millimho ( $m$ )**—Units of electrical conductance.

**Millimho ( $m$ )**—(See: MilliSiemens)

**Molar concentration**—Molar solution: Aqueous solution that contains one mole (unit = gram-molecular weight) of solute in one liter of water. For example: KCl (potassium chloride) molar concentration.

**Multiprobe**—The combination of several sensors, electrodes, or probe assemblies into a complete, stand-alone piece of equipment which simultaneously measures several parameters for profiling, spot-checking, or logging readings and data. A multiprobe is a multi-parameter instrument.

**Nitrate ( $NO_3^-$ )**—Nitrate is the most oxidized form of nitrogen, and is the primary form of biologically available nitrogen present in aerobic environments. Nitrate is a less toxic form of nitrogen than ammonia, and is readily assimilated by plants and bacteria.

**Oxidation reduction potential (or ORP)**—(See: Redox potential)

**Parameter**—A quantity which is constant under a given set of conditions, but may be different under other conditions.

**pH**—Describes the hydrogen-ion activity of a system: pH 0–7: acid solution, pH 7: neutral, pH 7–14: alkaline (or basic) solution. The "p" in pH stands for power (puissance) of the hydrogen ion ( $H^+$ ) activity. pH is a major factor affecting the availability of nutrients to plants and animals. It controls in part the concentration of many biochemically active substances dissolved in water, and it affects the efficiency of hemoglobin in the blood of vertebrates (e.g. fish) and invertebrates (e.g. shrimp), as well as the toxicity of pollutants.

**Probe**—A small tube containing the sensing elements of electronic equipment. The probe is an essential part of the water quality monitoring system, since it obtains measurements and data which can be stored, analyzed, and eventually transferred to a computer.

**Probe assembly**— (See: Assembly)

**Profiling**—Electrical exploration wherein the transmitter and receiver are moved in unison across a structure to obtain a profile of mutual impedance between transmitter and receiver = lateral search. In water quality, this term is used as the contrary of unattended monitoring. An operator connects the multiprobe to a computer equipped with a communications software. Then, he lowers the multiprobe in the water and receives measurements from the instrument. The data is displayed on the computer screen. The multiprobe can be lowered to different locations along the sample area in order to study the nature of the water based on several points of reference.

**Quinhydrone ( $C_6H_4O_2 \cdot C_6H_4(OH)_2$ )**—green, water-soluble powder. Quinhydrone is used to calibrate redox sensors. The quinhydrone's redox potential is dependent on the pH of the solution.

**Reading**—The indication shown by an instrument.

**Redox potential = Oxidation-reduction potential (or ORP) = Eh**—Voltage measured at an inert electrode immersed in a reversible oxidation-reduction system; measurement of the state of oxidation of the system. The redox potential measures the tendency of electrons to "flow" either toward or away from a noble metal electrode. A substance gains electrons in a reduction reaction and loses electrons in an oxidation reaction. ORP varies from substance to substance, and oxidation-reduction reactions occur simultaneously, hence the determination of the "potential" rather than of a discrete or qualitative value. Oxidation and reduction are in a constant state of flux, continuously seeking equilibrium. Applications for ORP measurement include, but are not limited to, the following: monitoring oxidation of cyanide and chromate wastes (e.g. metal plating), bleaching pulp (e.g. paper manufacturing), manufacture of bleach (e.g. monitoring chlorination), water pollution (e.g. acid mine drainage) and monitoring ozone treatment (e.g. water disinfection). ORP data has been used to understand more about how substances in sediments affect the water quality at the bottom of lakes, reservoirs, and ponds.

**Reduction**—A reaction that increases the electron content of a substance.

**Reference electrode**—A nonpolarizable electrode that generates highly reproducible potentials; used for pH, ORP, and ammonium measurements and polarographic analyses (e.g. silver-silver chloride electrode).

**Resistivity**—Resistivity is the electrical resistance offered by a material to the flow of current, times the cross-sectional area of current flow and per unit length of current path. It is the reciprocal of conductivity and is also known as electrical resistivity and specific resistance. Resistance declines as ion content increases.

**Response time**—The time required for a system to react, by a prescribed amount, to a step change in some variable. The extent of the response must be stated, as in "to 95% of total change" or "to within 0.1 mg/l of the final reading" (example for D.O.).

**Salinity**—Salinity is the measure of the total quantity of dissolved salts in water. Salinity refers to the ionic strength of natural waters. Salinity and salt concentration are the only terms that can be used when referring to the relative concentration of certain salts in bays, estuaries, and oceans.

**SDI-12**—SDI-12 is a standard used to interface data recorders with microprocessor-based sensors. SDI-12 stands for serial-digital interface at 1200 baud. SDI-12 is intended for applications with the following requirements: battery-powered operation with minimal current drain, low system cost, use of a single data recorder with multiple sensors on one cable, and up to 200 feet of cable between a sensor and a data recorder.

**Sensor**—The generic name for a device that senses either the absolute value or a change in a physical quantity such as temperature, pressure, flow rate, or pH, and converts that change into a useful input signal for an information-gathering system.

**Service loop**—A loop in a wire or cable to reduce the load on the wire or cable.

**Slope**—Slope is the operation applied to the system's response once the zero has been set. Slope is a measure of the sensitivity of a sensor. Slope scales the sensor's output to the correct units. (Also see: Zero)

**Specific conductance = conductivity at 25 °C**—The ratio of the electric current density to the electric field in a material. The ability of a fluid to conduct electricity. Specific conductance is the inverse of electrical resistivity, corrected at 25 °C, since fluids conduct more at higher temperatures.

**Spot-checking**—The collection of data using readings at irregular intervals.

**Temperature**—A measure of heat present in water. Aside from dissolved oxygen, temperature is considered the single most important parameter. Knowledge of water temperature is essential to the measurement of dissolved oxygen, conductivity (salinity), pH, alkalinity, biological/biochemical oxygen (needed to meet the metabolic needs of aerobic - requiring D.O. - organisms) and virtually every other water quality parameter. Temperature controls metabolism (utilization of inorganic and organic matter for life processes) of aquatic animals and plants. Temperature is largely responsible for biochemical reactions and is one of the most important cues for beginning and ending of spawning, migration, and many other phenomena.

**Titration**—A method of analyzing the composition of a solution by adding known amounts of standardized solution until a given reaction - color change, precipitation, or conductivity change - is produced. Winkler titration (in calibration): A wet chemical method for estimating the D.O. in water.

**Tolerance**—Refers to the maximum difference between the true value of a parameter and the actual "operator-acceptable" reading. Usually used as a synonym for accuracy.

**Total dissolved gas (TDG)**—The amount of gaseous compounds dissolved in a liquid.

**Total dissolved solids (TDS)**—The amount of materials in a body of water that are dissolved or too small to be filtered. These solids include ions, which are important to the internal water balance in aquatic organisms. The amount of substances (calculated in Kg/l) dissolved in one liter of water. A measure primarily of alkaline earth metals and their salts dissolved or in very fine suspension. It provides information regarding the potential buffering capacity of water, water hardness, and the potential lethality of toxins. The concentration of dissolved solids affects osmoregulation (salt balancing) and is often a cue for migration and spawning. TDS concentration affects the buoyancy of fish eggs and other organisms.

**Transducer**—Any device or element which converts an input signal into an output signal of a different form (ex: doorbell, microphone). The depth or vented level transducer.

**Turbidity**—The measure of the clarity of a liquid by using colorimetric scales. It is also the expression of the optical property that causes a light to be scattered and absorbed rather than transmitted in straight lines through a sample. Turbidity is the opposite of clarity (ITM) A measure of the opacity or translucence of water. The main objective is to determine the scattering of light by particles of a body of water and report that scattering in some unit of measurement, usually nephelometric turbidity units (or NTU) based on a primary turbidity standard called formazin. Turbidity is caused by plankton (both animal and plant), clay, suspended clay, silt, etc. Although these substances impart color, color resulting from turbidity is referred to as "apparent color" and should not be confused with true color (resulting from dissolved substances). Apparent color can also result from overshadowing by vegetation or substrate (bottom material) color.

**Vented depth**—(ITM) The multiprobe transducer measuring depth from 0 to 10 meters. (See: Depth)

**Zero**—(ITM) A system's "zero" is an anchor point set either temporarily by calibration or permanently by design. This point can easily be established either electronically or by using laboratory standards. (Also see: Slope).



## Abbreviations

<b>AgCl</b>	Silver Chloride	<b>MS</b>	MiniSonde
<b>Ah</b>	Ampere hour	<b>mS/cm</b>	MilliSiemens per centimeter
<b>AWG</b>	American wire gauge	<b>mV</b>	Millivolt
<b>BDR</b>	Basic data recorder	<b>nm</b>	Nanometer
<b>BP</b>	Battery pack; barometric pressure	<b>PA</b>	Probe Assembly
<b>CC</b>	Calibration cable	<b>PCB</b>	Printed circuit board
<b>°C</b>	Degrees Celsius (centigrade)	<b>ppt</b>	Part per thousand
<b>CSV</b>	Comma-separated value	<b>psu</b>	Practical salinity unit
<b>DS</b>	DataSonde	<b>psiag</b>	Pound per square inch absolute
<b>EPA</b>	External battery pack	<b>psig</b>	Pound per square inch gage
<b>°F</b>	Degrees Fahrenheit	<b>RBP</b>	Rechargeable battery pack
<b>GFI</b>	Ground fault interrupt (device)	<b>RGA</b>	Returned good authorization
<b>IBP</b>	Internal battery pack	<b>SDI</b>	Serial-digital interference
<b>IC</b>	Interface cable	<b>STDREF</b>	Standard reference electrode
<b>K</b>	Degrees Kelvin, or kelvin. A unit of absolute temperature.	<b>CIRCLTR</b>	FreshFlow™ miniature sample circulator
<b>KCl</b>	Potassium chloride	<b>SVR</b>	Surveyor
<b>l or L</b>	Liter	<b>WSG</b>	Weighted sensor guard
<b>mmHG</b>	Millimeter of mercury (hectoPascal and millibar also used in Europe)	<b>4PF</b>	4-pin female connector
<b>mil</b>	A unit of length, equal to 0.001 inch	<b>4PM</b>	4-pin male connector
<b>...M KCl</b>	...molar potassium chloride	<b>6PF</b>	6-pin female connector
<b>µm</b>	Micrometer	<b>6PM</b>	6-pin male connector
<b>m</b>	Millimho = milliSiemens (mS)	<b>9PF</b>	9-pin connector
<b>µS/cm</b>	MicroSiemens per centimeter = micromho per cm	<b>9PM</b>	9-pin male connector
<b>m</b>	Meter ( 1 meter = 3.281 ft)		

Document number  
55.495.000.B.E 02-0511

## **OTT Hydromet GmbH**

Ludwigstrasse 16  
87437 Kempten • Germany  
Phone +49 8 31 56 17-0  
Fax +49 8 31 56 17-209

[info@ott.com](mailto:info@ott.com)  
[www.ott.com](http://www.ott.com)