

## Ternary Complex Method

Method 8169

0.1 to 12.0 mg/L Mo

Powder Pillows

**Scope and application:** For boiler and cooling tower waters.



### Test preparation

#### Before starting

The sample temperature must be 20–25 °C (68–77 °F) for accurate results.
Always do tests in sample cells. Do not put the instrument in the sample or pour the sample into the cell holder.
Make sure that the sample cells are clean and there are no scratches where the light passes through them.
Rinse the sample cell and cap with the sample three times before the sample cell is filled.
Make sure that there are no fingerprints or liquid on the external surface of the sample cells. Wipe with a lint-free cloth before measurement.
Cold waters can cause condensation on the sample cell or bubbles in the sample cell during color development. Examine the sample cell for condensation or bubbles. Remove condensation with a lint-free cloth. Invert the sample cell to remove bubbles.
Install the instrument cap over the cell holder before ZERO or READ is pushed.
The results can be expressed as mg/L molybdate ( $\text{MoO}_4^{2-}$ ) or mg/L sodium molybdate ( $\text{Na}_2\text{MoO}_4$ ) by multiplying the mg/L molybdenum ( $\text{Mo}^{6+}$ ) result by 1.67 or 2.15, respectively.
After the test, immediately empty and rinse the sample cell. Rinse the sample cell and cap three times with deionized water.
After several analyses, the sample cells may have a blue discoloration. Clean the sample cells with 6.0 N (1:1) hydrochloric acid, then rinse thoroughly with deionized water.
For the best results, measure the reagent blank value for each new lot of reagent. Replace the sample with deionized water in the test procedure to determine the reagent blank value. Subtract the reagent blank value from the sample results.
Highly buffered samples or extreme pH may exceed the buffering capacity of the reagent and require sample pre-treatment.
Review the Safety Data Sheets (MSDS/SDS) for the chemicals that are used. Use the recommended personal protective equipment.
Dispose of reacted solutions according to local, state and federal regulations. Refer to the Safety Data Sheets for disposal information for unused reagents. Refer to the environmental, health and safety staff for your facility and/or local regulatory agencies for further disposal information.

#### Items to collect

Description	Quantity
Molybdenum 1 Reagent (LR) Molybdate Powder Pillow, 20-mL	1
Molybdenum 2 Reagent Solution	0.5 mL
Cylinder, graduated mixing, 25-mL	1
Sample cells, 25-mm (10 mL)	2

Refer to [Consumables and replacement items](#) on page 5 for order information.

#### Sample collection

- Analyze the samples immediately. The samples cannot be preserved for later analysis.
- Collect samples in clean glass or plastic bottles.

- Filter samples that are turbid with filter paper and a funnel.

## Powder pillow procedure



**1. Set the instrument to high range (HR).**  
For DR300, push the up arrow button. For PCII, push the menu button, checkmark button, then the menu button again.

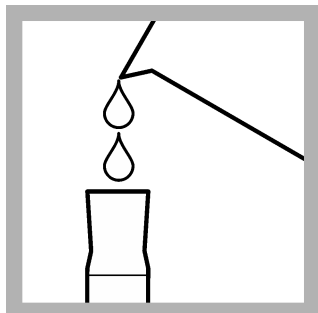

**2. Prepare the sample:** Fill a 25-mL graduated mixing cylinder with 5 mL of sample.



**3. Add deionized water to the 20-mL mark.**

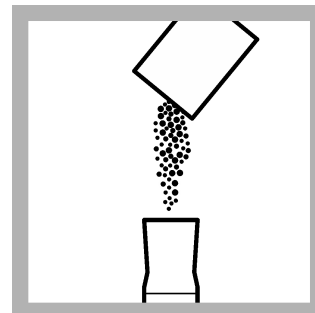

**4. Add the contents of one Molybdenum 1 Reagent Powder Pillow to the mixing cylinder.**

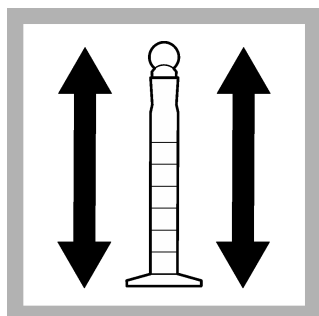

**5. Close the cylinder.** Gently shake or invert the cylinder to completely dissolve the reagent.

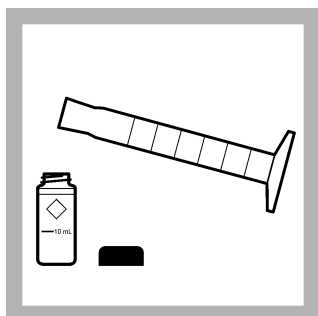

**6. Fill a sample cell with 10 mL of the prepared sample.**

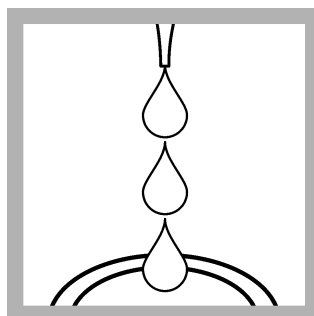

**7. Develop the sample:** Add 0.5 mL of Molybdenum 2 Reagent Solution to the prepared sample cell.

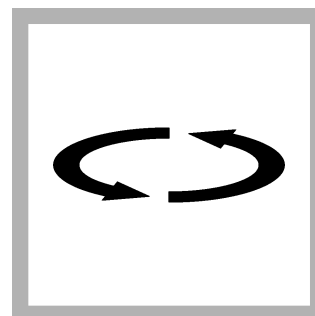

**8. Swirl to mix.** A green color will show if molybdenum is in the sample.



**9. Set and start a timer for 2 minutes.** A 2-minute reaction time starts.

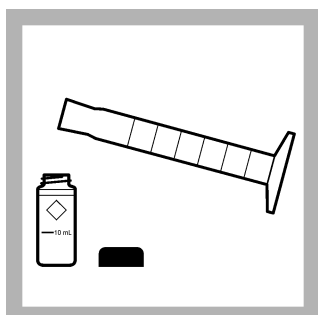

**10. Prepare the blank:** When the timer expires, fill a second sample cell with 10 mL of the prepared sample.

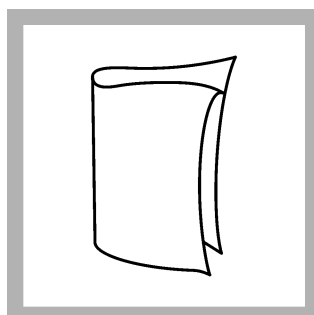

**11. Clean the blank sample cell.**

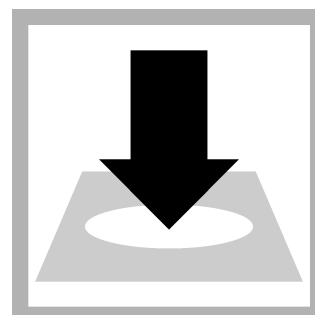

**12. Insert the blank into the cell holder.** Point the diamond mark on the sample cell toward the keypad.

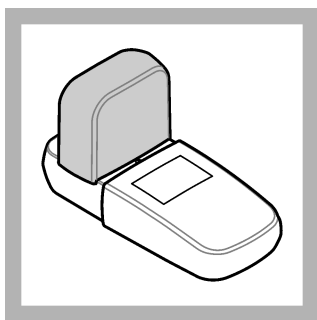

13. Install the instrument cap over the cell holder.

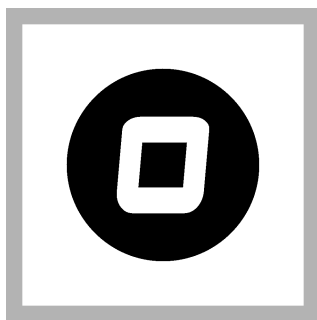

14. Push **ZERO**. The display shows "0.0".

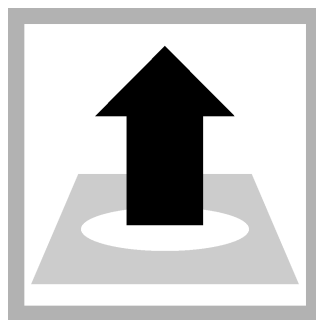

15. Remove the sample cell from the cell holder.

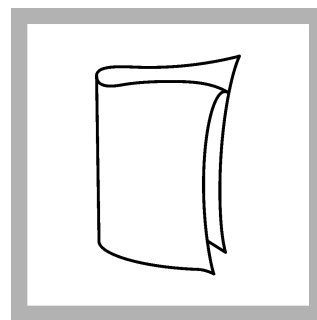

16. Clean the developed sample.

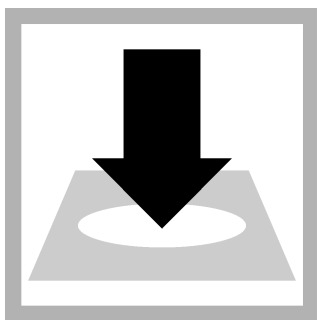

17. Insert the developed sample into the cell holder. Point the diamond mark on the sample cell toward the keypad.

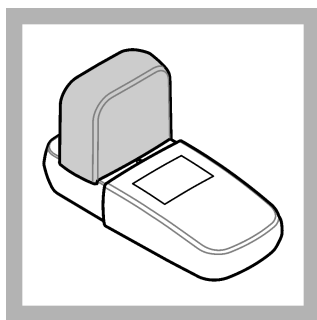

18. Install the instrument cap over the cell holder.

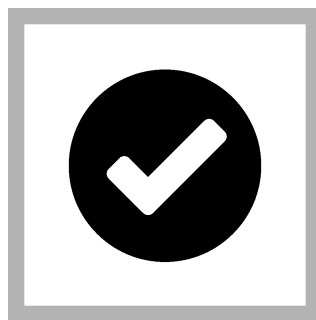

19. Push **READ**. Results show in mg/L molybdenum (Mo).

## Interferences

Interference studies were completed with a molybdenum standard solution of 2 mg/L  $\text{Mo}^{6+}$  that included the potential interfering ion. When the standard solution concentration changed by  $\pm 5\%$  with a given ion concentration, the ion was considered to be a substance that interferes. Interference results are summarized in [Table 1](#), [Table 2](#) and [Table 3](#).

**Table 1 Substances that cause a negative interference**

Interfering substance	Interference level
Alum	More than 7 mg/L
Aluminum	More than 2 mg/L
AMP (Phosphonate)	More than 15 mg/L
Bicarbonate	More than 5650 mg/L
Bisulfate	More than 3300 mg/L
Borate	More than 5250 mg/L
Chloride	More than 1400 mg/L
Chromium	More than 4.5 mg/L. Read the molybdenum concentration immediately after the 2-minute reaction period.
Copper	More than 98 mg/L
Diethanoldithiocarbamate	More than 32 mg/L
EDTA	More than 1500 mg/L
Ethylene Glycol	More than 2% (by volume)

**Table 1 Substances that cause a negative interference (continued)**

Interfering substance	Interference level
Highly buffered samples or extreme sample pH	Can prevent the correct pH adjustment (of the sample) by the reagents. Sample pretreatment may be necessary. Adjust to pH 3–5 with acid (Sulfuric Acid, 1 N) or base (Sodium Hydroxide, 1 N). Correct the test result for the dilution from the volume additions.
Iron	More than 200 mg/L
Lignin Sulfonate	More than 105 mg/L
Nitrite	More than 350 mg/L
Orthophosphate	More than 4500 mg/L
Phosphonohydroxyacetic Acid	More than 32 mg/L
Phosphonate HEDP	Positive interference of about 10% up to 30 mg/L. As the concentration increases above 30 mg/L, a decrease in the molybdenum concentration reading occurs (negative interference).
Sulfite	More than 6500 mg/L

**Table 2 Substances that cause a positive interference**

Interfering substance	Interference level
Benzotriazole	More than 210 mg/L
Carbonate	More than 1325 mg/L
Morpholine	More than 6 mg/L
Phosphonate HEDP	The presence of the phosphonate HEDP at concentrations up to 30 mg/L will increase the apparent molybdenum concentration reading by approximately 10% (positive interference). Multiply the test result by 0.9 to get the actual Mo <sup>6+</sup> concentration.
Silica	More than 600 mg/L

**Table 3 Non-interfering substances**

Interfering substance	Interference level
Bisulfite	9600 mg/L
Calcium	720 mg/L
Chlorine	7.5 mg/L
Magnesium	8000 mg/L
Manganese	1600 mg/L
Nickel	250 mg/L
PBTC (phosphonate)	500 mg/L
Sulfate	12,800 mg/L
Zinc	400 mg/L

## Accuracy check

### Standard additions method

Use the standard additions method to validate the test procedure, reagents and instrument and to find if there is an interference in the sample.

Items to collect:

- Molybdenum Standard Solution, 1000 mg/L Mo<sup>6+</sup>
- Graduated cylinder, 250 mL

- Pipet, TenSette®, 0.1–1.0 mL and tips
  - Erlenmeyer flasks (3)
1. Prepare three spiked samples: use the TenSette pipet to add 0.1 mL, 0.2 mL and 0.3 mL of the standard solution, respectively, to three 200-mL portions of fresh sample. Mix well.
  2. Use the test procedure to measure the concentration of each of the spiked samples. Start with the smallest sample spike. Measure each of the spiked samples in the instrument.
  3. Compare the expected result to the actual result. The expected molybdenum concentration increase is approximately 2.0 mg/L for each 0.1 mL of standard added.

### Standard solution method

Use the standard solution method to validate the test procedure, the reagents and the instrument.

Items to collect:

- Molybdenum Standard Solution, 10.00-mg/L
1. Use the test procedure to measure the concentration of the standard solution.
  2. Compare the expected result to the actual result.

**Note:** The factory calibration can be adjusted slightly with the standard calibration adjust option so that the instrument shows the expected value of the standard solution. The adjusted calibration is then used for all test results. This adjustment can increase the test accuracy when there are small variations in the reagents or instruments.

### Method performance

The method performance data that follows was derived from laboratory tests that were measured on a DR300 and a Pocket Colorimeter II during ideal test conditions. Users can get different results under different test conditions.

Precision (95% confidence interval)
10.00 ± 0.1 mg/L Mo

### Summary of method

Molybdate is determined with the ternary complex method by the reaction of molybdate molybdenum with an indicator and a sensitizing agent that results in a stable blue complex. While molybdate ( $\text{MoO}_4^{2-}$ ) is the actual chemical species used in the chemistry, the instrument shows the result as molybdenum, Mo.

### Consumables and replacement items

#### Required reagents

Description	Quantity/test	Unit	Item no.
Molybdenum Reagent Set, 20 mL, includes:	—	100 tests	2449400
Molybdenum 1 Reagent (LR) Molybdate Powder Pillow, 20-mL	1	100/pkg	2352449
Molybdenum 2 Reagent Solution	0.5 mL	50 mL MDB	2352512

#### Required apparatus

Description	Quantity/test	Unit	Code
Sample cells, 10-mL round, 25 mm x 60 mm	2	6/pkg	2427606
Mixing cylinder, graduated, 25 mL with stopper	1	each	2088640

## Recommended standards

Description	Unit	Item no.
Molybdenum Standard Solution, 10-mg/L as Mo	100 mL	1418742
Molybdenum Standard Solution, 1000-mg/L as Mo	100 mL	1418642
Water, deionized	4 L	27256

## Optional reagents and apparatus

Description	Unit	Item no.
Graduated cylinder, 250 mL	each	108146
Filter paper, 2–3-micron, pleated, 12.5-cm	100/pkg	189457
Funnel, poly, 65 mm	each	108367
Pipet, TenSette <sup>®</sup> , 0.1–1.0 mL	each	1970001
Pipet tips for TenSette <sup>®</sup> Pipet, 0.1–1.0 mL	50/pkg	2185696
Flask, Erlenmeyer, 250 mL	each	50546
Pipet, volumetric, Class A, 10 mL	each	1451538
Pipet filler, safety bulb	each	1465100
Hydrochloric Acid Solution, 6.0 N (1:1)	500 mL	88449
Sodium Hydroxide Standard Solution, 1.0 N	100 mL MDB	104532
Sulfuric Acid Standard Solution, 1 N	100 mL MDB	127032



FOR TECHNICAL ASSISTANCE, PRICE INFORMATION AND ORDERING:  
In the U.S.A. – Call toll-free 800-227-4224  
Outside the U.S.A. – Contact the HACH office or distributor serving you.  
On the Worldwide Web – [www.hach.com](http://www.hach.com); E-mail – [techhelp@hach.com](mailto:techhelp@hach.com)

HACH COMPANY  
WORLD HEADQUARTERS  
Telephone: (970) 669-3050  
FAX: (970) 669-2932